

INDIVIDUAL PARTS / FAUCET REPAIRS

REPLACEMENT HANDLES AND ADAPTERS

1 CREST/GOOD FIT-ALL HANDLE ASSORTMENT

24 HANDLES,
75+ ADAPTERS,
AND MORE!



CAT NO. 261C990 **DESCRIPTION** Fit All Handle Assortment

Crest/Good's fit-all replacement handle assortment offers a quick and easy system for replacing faucet and shower handles. Save time and money over stocking OEM handles by reducing over 80 OEM handle choices with these 6 different sized handles.

Use this kit for basins, sinks, and tubs for a perfect fit every time. Kit includes 16 handles, 60 adapters, 60 handle screws (with Jiffy Tap,) broach selector, and instruction chart, packed in a heavy duty metal suitcase.



CAT NO. 591 I 095 **DESCRIPTION** Broach selector

3 INDIVIDUAL FIT-ALL METAL REPLACEMENT HANDLES

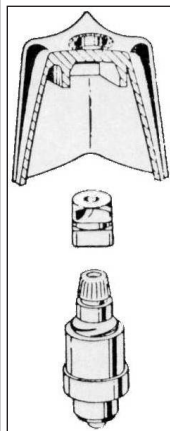

LARGE CANOPY

2" Wide
1-3/4" Tall

261 C 971

MEDIUM LARGE CANOPY

2" Wide
1-1/2" Tall

261 C 972

MEDIUM CANOPY

2" Wide
1-1/4" Tall

261 C 973

SMALL CANOPY

1-7/8" Wide
1" Tall

261 C 974

LARGE LEVER

1-5/8" Wide (base)
2-1/2" Wide (overall)
1-1/4" Tall

262 C 966

SMALL LEVER

1-3/8" Wide (base)
2-1/2" Wide (overall)
1-1/4" Tall

262 C 965

CAT NO.	DESCRIPTION
261 C 971	Large Canopy Fit All Handles (PAIR)
261 C 972	Medium Large Canopy Fit All Handles (PAIR)
261 C 973	Medium Canopy Fit All Handles (PAIR)
261 C 974	Small Canopy Fit All Handles (PAIR)
262 C 966	Large Lever Fit All Handles (PAIR)
262 C 965	Small Lever Fit All Handles (PAIR)

7 INDIVIDUAL FIT-ALL DECO REPLACEMENT HANDLES

Replace cross or canopy shower handles with these new cross handles. Our exclusive design features a solid brass insert to match many brands. Sold as a pair, or as a single diverter handle.



H & C CAT NO:	DIVERTER CAT NO:	MFR:
VP601	VP651	American Std
VP602	VP652	Briggs
VP603	VP653	Central Brass
VP604	VP654	Chicago
VP605	VP655	Gerber
VP606	VP656	Kohler
VP607	VP657	Price Pfister
VP608	VP658	Repcal
VP609	VP659	Savoy
VP610	VP660	Sayco

Every kit includes either hot & cold, or diverter handle, plus: matching brass broach inserts, screws, & porcelain buttons.

INDIVIDUAL FIT-ALL LUCITE CLEAR REPLACEMENT HANDLES

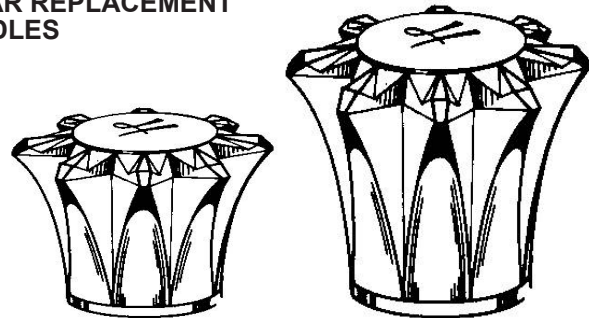

261 C 975

261 C 981

CAT NO.	DESCRIPTION
261 C 975	SMALL Lucite Fit All Handles (H & C)
261 C 978	SMALL Lucite Fit All Handles (Diverter)
261 C 981	LARGE Lucite Fit All Handles (H & C)
261 C 984	LARGE Lucite Fit All Handles (Diverter)



INDIVIDUAL PARTS / FAUCET REPAIRS

REPLACEMENT HANDLES AND ADAPTERS

FIT-ALL REPLACEMENT HANDLES WITH VISE-GRIP LOCK

These handles feature an exclusive "VISE-GRIP-LOCK" system that holds tightly to badly worn broaches. Tightening screws on each side of the attached adapter locks the handle onto the stem.



VP 100



VP 200



VP 400

CAT NO.	DESCRIPTION
VP100	Cross Handles (H & C)
VP200	Lever Handles (H & C)
VP400	Lucite Handles (H & C)

FIT-ALL WRIST BLADE HANDLES

These handles come complete with adapters shown below.

A less expensive alternative to OEM wrist handles.

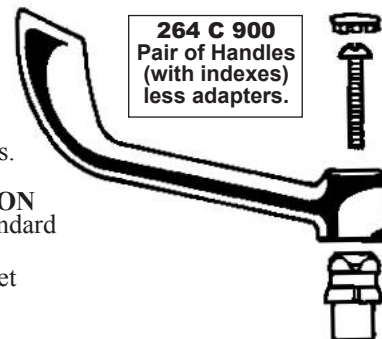

264 C 900
Pair of Handles
(with indexes)
less adapters.

CAT NO.	DESCRIPTION
AS90HX	American Standard
CB90HX	Central Brass
CF90HX	Chicago Faucet
CR90HX	Crane
EJ90HX	Eljer
KO90HX	Kohler
SC90HX	Sayco
SP90HX	Speakman
TS90HX	T&S Brass

Each kit includes hot & cold wrist blade handles, matching brass broach inserts, screws, and chrome index buttons.

HANDLE SCREWS AND ADAPTERS

CHROME PLATED BRASS HANDLE SCREWS

Save money with our exclusive 10-24 handle screws & Jiffy Tap tool... One thread size to fit all faucet handles. Our handle screw assortment includes tap tool plus screw chart and manufacturers' listing of charts.



ROUND HEAD



TRUSS HEAD



OVAL HEAD



FILLISTER HEAD

CAT NO.	#	HEAD:	SIZE:	
226 C 002	107	Round	8-32	x 1/2"
947 B 300		Round	8-32	x 3/4"
227 C 067		Round	8-32	x 1"
227 C 001*	110	Round	10-24	x 3/8"
227 C 002*	111	Round	10-24	x 1/2"
227 C 066		Round	10-24	x 1"
941 B 003		Round	10-24	x 1-3/4" (plain brass)
861 A 010		Round	10-32	x 3/4" (plain brass)
227 C 068		Round	10-32	x 1"
947 S 021		Truss	4-40	x 1/2"
227 C 003	112	Truss	10-24	x 3/8"
227 C 016		Truss	10-24	x 1/2"
227 C 006*	115	Lg. Oval	10-24	x 3/8"
227 C 007*	116	Lg. Oval	10-24	x 1/2"
227 C 008	120	Lg. Oval	10-32	x 1/2"
227 C 017*	1970	Lg. Oval	10-24	x 3/4"
947 S 687		Oval	6-32	x 3/8"
227 C 015		Oval	8-32	x 1/2"
227 C 028		Oval	8-32	x 3/4"
227 C 030		Oval	8-32	x 1-3/4"
227 C 024*	117	Oval	10-24	x 5/8"
227 C 026*	119	Oval	10-24	x 1-1/2"
227 C 029		Oval	10-24	x 2-1/2" (PAIR)
960 A 310		Oval	10-28	x 1/2"
227 C 027	122	Oval	10-32	x 3/4"
227 C 009	103	Fillister	8-32	x 5/16" (plain brass)

*(included in kit shown below.)

9AS6611 28611 Set of 3 specialty screws for Am Std



HANDLE SCREW ASSORTMENT

103 piece assortment

(Includes starred sizes listed above, plus tap tool)

CAT NO.	#
227 C 090	70



INDIVIDUAL ADAPTERS FOR FIT ALL HANDLES

Insert these adapters into any handle on this page to change the look of your faucet or shower.

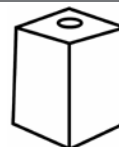

CRESTOLAC

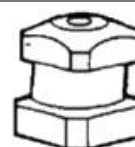

BRASS

CRESTOLAC ADAPTER CAT NO:	BRASS ADAPTER CAT NO:	#:	MFR:	BROACH:
260 P 101	261 C 900	1-1	Crane	12 pt
260 P 102	261 C 901	1-2	Price Pfister	12 pt
	261 C 902	1-4	Am Std, Sterling	22 pt
	261 C 903	1-5	Am Std, Sterling	16 pt
	261 C 904	1-6	Central, Eljer, Savoy	16 pt
260 P 105	261 C 905	1-7	Kohler	19 pt
260 P 106	261 C 906	1-8	Am Std	20 pt
	261 C 907	1-12	Harcraft	12 pt
	261 C 921	1-13	Savoy, Wolverine	15 pt
	261 C 908	2-1	Am Std (Aquaseal)	22 pt
260 P 110	261 C 909	2-2	Youngstown	16 pt
	261 C 910	2-3	Gerber, Sayco	16 pt
	261 C 911	2-4	Speakman	20 pt
260 P 113	261 C 912	2-5	Price Pfister	12 pt
	261 C 913	2-6	Am Std (Colony)	16 pt
260 P 115	261 C 914	3-1	Repcal	12 pt
260 P 116	261 C 915	3-2	Sayco	16 pt
	261 C 916	3-3	Indiana, Union Br	18 pt
	261 C 917	3-4	Barnes, Central	16 pt
	261 C 918	3-7	Am Brs, Empire, Strmwy	17 pt
260 P 120	261 C 919	3-9	Harcraft	12 pt
260 P 121	261 C 920	3-10	Sears, Universal	12 pt
	261 C 926	3-11	Crane Repcal	16 pt
	261 C 924	3-12	Chicago (square)	---
	261 C 922	4-1	Fit All (Screw-on)	---
	261 C 925	4-2	Fit All (with hex screws)	---
	261 C 923	5-1	Am Std Hospital	22 pt



"1" series adapters are 7/16" tall



"2" series adapters are 9/16" tall

















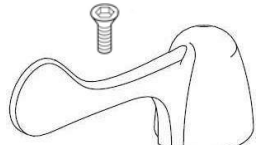



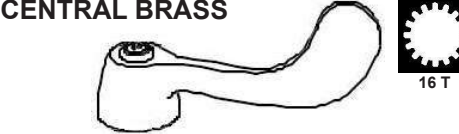
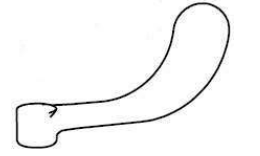

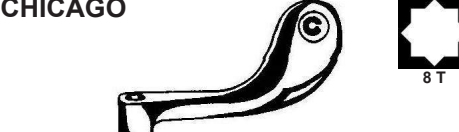
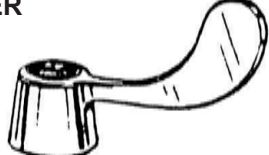
"3" series adapters are 5/8" tall

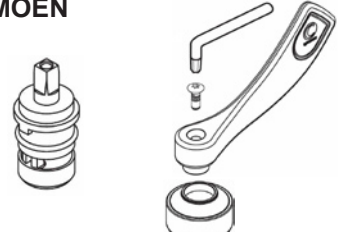

INDIVIDUAL PARTS / FAUCET REPAIRS

OEM WRIST BLADE HANDLES

<p>1 AMERICAN STANDARD</p>  <p>(4" LONG) (6" LONG)</p> <p>CAT NO. DESCRIPTION AS 10H 4" Pair, with indexes & screws AS381-6 6" Hot only, w/ index & screw AS382-6 6" Cold only, w/ index & screw 121C075 Index buttons (Pair - chrome) 9AS1038 Index buttons (Pair - colored) 227C002 Handle Screw (each)</p>	<p>CRANE</p>  <p>CAT NO. DESCRIPTION CR12H 4" pair, with index nut CR16019 4" hot handle, w/ index nut CR16020 4" cold handle, w/ index nut CR16015 4" handle only, LESS index nut (12857) 9CR1552 6" handle only, LESS index nut (13749) 121C061 Hot index nut only 121C060 Cold index nut only</p>	<p>KOHLER</p>  <p>5" wrist blade</p> <p>CAT NO. DESCRIPTION KO90H 5" Pair, with indexes & screws</p>
<p>2 AMERICAN STANDARD</p>  <p>AS68H, AS69H</p> <p>CAT NO. DESCRIPTION AS66H Pair of grips, indexes, & screws (12676) AS68H Pr, complete (above deck faucets) (172) AS69H Pr, complete (below deck faucets) (372) 9AS6068 Handle screw (3 pack) 9AS6069 Skirt only, tall (above deck- #12167) 9AS6070 Skirt only, short (below deck#12181) 9AS6071 Index buttons (Pair - chrome) 9AS6072 Index rings (Pair - colored)</p>	<p>CRESTLINE</p>  <p>ALSO FITS ON PRE-2011 DELTA "DELEX" FAUCETS.</p> <p>CAT NO. DESCRIPTION CL06H Pair, with indexes & screws Hot index only Cold index only Handle Screw (each)</p>	<p>KOHLER</p>  <p>6" wrist blade</p> <p>CAT NO. DESCRIPTION 9KO2955 6" Hot only, w/ screw 9KO2954 6" Cold only, w/ screw 226C003 Handle Screw (each)</p>
<p>3 AMERICAN STANDARD</p>  <p>WRIST LEVER</p> <p>CAT NO. DESCRIPTION DE06H Pair, w/indexes & screws (RP12491) 944R060 Red & Blue Screws only.(RP12490)</p>	<p>DELTA</p>  <p>CAT NO. DESCRIPTION EJ90H Pair, with indexes & screws EJ2188 Hot only, w/ index & screw EJ2189 Cold only, w/ index & screw</p>	<p>KOHLER</p>  <p>4" wrist blade base diam = 1-5/16"</p> <p>CAT NO. DESCRIPTION 9KO3028 Pair, with indexes & screws 9KO3027 Hot only, w/ index & screw 9KO3026 Cold only, w/ index & screw 226C003 Handle Screw (each)</p>
<p>4 AMERICAN STANDARD</p>  <p>WRIST LEVER</p> <p>CAT NO. DESCRIPTION 9AS5210 ONE lever handle, buttons, & screw 9AS5217 ONE wrist blade, buttons, & screw 9AS6073 CP Bonnet nut</p>	<p>ELJER</p>  <p>CAT NO. DESCRIPTION 937C166 ONE handle. with indexes & screws 121C017 Hot index only 121C016 Cold index only</p>	<p>KOHLER</p>  <p>4" wrist blade base diam = 1-3/4"</p> <p>CAT NO. DESCRIPTION 9KO3034 Pair, with indexes & screws 9KO3033 Hot only, w/ index & screw 9KO3032 Cold only, w/ index & screw 226C003 Handle screw (each)</p>
<p>5 AMERICAN STANDARD</p>  <p>WRIST LEVER</p> <p>CAT NO. DESCRIPTION CB10H Pair, with indexes & screws 9CB6066 Hot index only 9CB6067 Cold index only</p>	<p>FISHER</p>  <p>CAT NO. DESCRIPTION MO6603 Hot only, w/ screw (52011) MO6604 Cold only, w/ screw (52010) MO6605 Handle Hub Kit (52002) MO6606 Ceramic cart, H (52000) MO6607 Ceramic cart, C (52001) MO6609 Torx Wrench (52005)</p>	<p>KOHLER</p>  <p>5" wrist blade</p> <p>CAT NO. DESCRIPTION 9KO3028 Pair, with indexes & screws 9KO3027 Hot only, w/ index & screw 9KO3026 Cold only, w/ index & screw 226C003 Handle Screw (each)</p>
<p>6 AMERICAN STANDARD</p>  <p>WRIST LEVER</p> <p>CAT NO. DESCRIPTION 9AS5210 ONE lever handle, buttons, & screw 9AS5217 ONE wrist blade, buttons, & screw 9AS6073 CP Bonnet nut</p>	<p>GERBER</p>  <p>CAT NO. DESCRIPTION GB06H Pair, with indexes & screws</p>	<p>KOHLER</p>  <p>4" wrist blade base diam = 1-3/4"</p> <p>CAT NO. DESCRIPTION 9KO3034 Pair, with indexes & screws 9KO3033 Hot only, w/ index & screw 9KO3032 Cold only, w/ index & screw 226C003 Handle screw (each)</p>
<p>7 CENTRAL BRASS</p>  <p>CAT NO. DESCRIPTION 9CF0578 Hot index only 9CF0580 Cold index only 227C008 Handle Screw (each) 9CF0579 Vandal Proof Screw (each)</p>	<p>MOEN</p>  <p>CAT NO. DESCRIPTION MO6603 Hot only, w/ screw (52011) MO6604 Cold only, w/ screw (52010) MO6605 Handle Hub Kit (52002) MO6606 Ceramic cart, H (52000) MO6607 Ceramic cart, C (52001) MO6609 Torx Wrench (52005)</p>	<p>MOEN</p>  <p>CAT NO. DESCRIPTION MO6603 Hot only, w/ screw (52011) MO6604 Cold only, w/ screw (52010) MO6605 Handle Hub Kit (52002) MO6606 Ceramic cart, H (52000) MO6607 Ceramic cart, C (52001) MO6609 Torx Wrench (52005)</p>
<p>8 CHICAGO</p>  <p>CAT NO. DESCRIPTION CF90H Pair, with indexes & screws</p>	<p>MOEN</p>  <p>CAT NO. DESCRIPTION MO6603 Hot only, w/ screw (52011) MO6604 Cold only, w/ screw (52010) MO6605 Handle Hub Kit (52002) MO6606 Ceramic cart, H (52000) MO6607 Ceramic cart, C (52001) MO6609 Torx Wrench (52005)</p>	<p>MOEN</p>  <p>CAT NO. DESCRIPTION MO6603 Hot only, w/ screw (52011) MO6604 Cold only, w/ screw (52010) MO6605 Handle Hub Kit (52002) MO6606 Ceramic cart, H (52000) MO6607 Ceramic cart, C (52001) MO6609 Torx Wrench (52005)</p>
<p>9 CHICAGO</p> <p>CAT NO. DESCRIPTION CF90H Pair, with indexes & screws</p>	<p>MOEN</p> <p>CAT NO. DESCRIPTION MO6603 Hot only, w/ screw (52011) MO6604 Cold only, w/ screw (52010) MO6605 Handle Hub Kit (52002) MO6606 Ceramic cart, H (52000) MO6607 Ceramic cart, C (52001) MO6609 Torx Wrench (52005)</p>	<p>MOEN</p> <p>CAT NO. DESCRIPTION MO6603 Hot only, w/ screw (52011) MO6604 Cold only, w/ screw (52010) MO6605 Handle Hub Kit (52002) MO6606 Ceramic cart, H (52000) MO6607 Ceramic cart, C (52001) MO6609 Torx Wrench (52005)</p>



INDIVIDUAL PARTS / FAUCET REPAIRS

OEM WRIST BLADE HANDLES (cont.)

MOEN

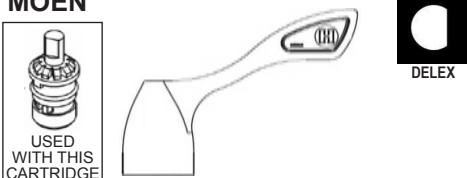

USED WITH THIS CARTRIDGE

CAT NO. MO6601
MO6602
MO6606

DESCRIPTION
Hot only, w/ Screw (121444)
Cold only, w/ screw (121443)
Torx Wrench (52005)

DELEX

SAVOY

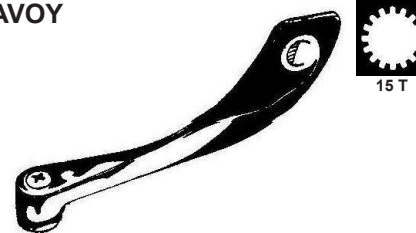

CAT NO. SV90HX
227C007

DESCRIPTION
Pair, with indexes & screws
Handle Screw (each)

15 T

T&S BRASS



4" LONG VERSION:

CAT NO. TS90H
9TS1384
9TS1394

DESCRIPTION
Pair, w/ index & screws (generic)
Hot only, w/ index & screw (OEM)
Cold only, w/ index & screw (OEM)

20 T

MOEN

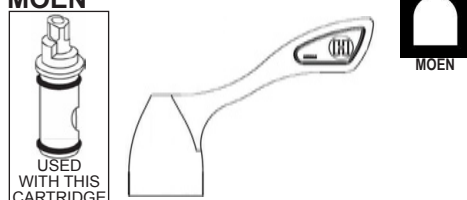

USED WITH THIS CARTRIDGE

CAT NO. MO834
MO838

DESCRIPTION
Hot only, w/ Screw (14834)
Cold only, w/ screw (14838)

MOEN

SPEAKMAN



4" LONG VERSION:

CAT NO. SP6604

DESCRIPTION
SINGLE HANDLE, index & screw

6" LONG VERSION

CAT NO. SP6606
226C003

DESCRIPTION
SINGLE HANDLE, index & screw
Handle screw

20 T

WATERSAVER FAUCET

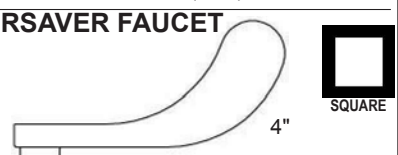

CAT NO. WS06H
121C043
121C042
227C002

DESCRIPTION
SINGLE handle, index & screw
Hot index only
Cold index only
Handle screw

SQUARE

PRICE/PFISTER

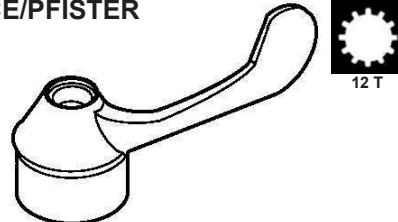

CAT NO. PF06H

DESCRIPTION
SINGLE handle, index & screw

12 T

SYMMONS



CAT NO. 947S675

DESCRIPTION
Wrist handle, single

ZURN



CAT NO. ZR90H

DESCRIPTION
Pair, with indexes & screws

8 T

SINGLE LEVER & KNOB FAUCET HANDLES

AMERICAN STANDARD

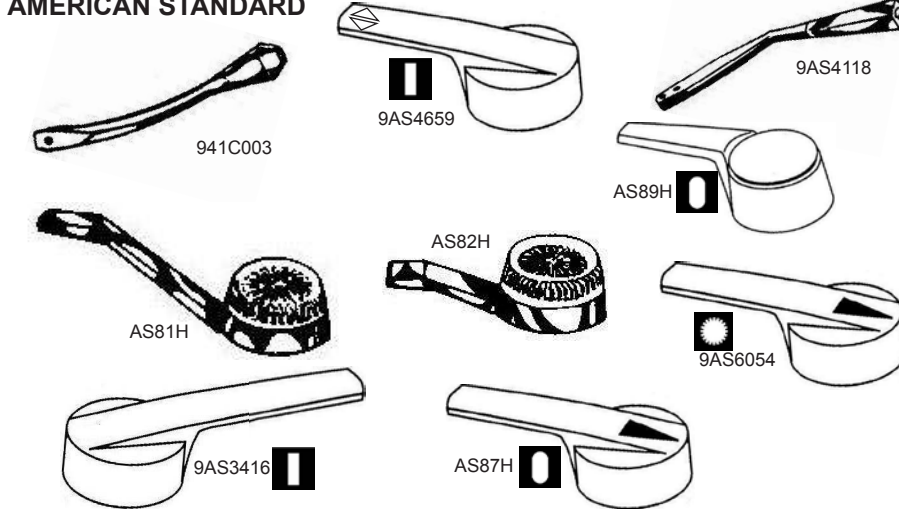

CAT NO. 941C003
9AS4118
9AS3416
9AS4659
AS81H
AS82H
9AS6054
AS81H
AS82H
AS87H
AS89H

DESCRIPTION
Older single lever lav
Older single lever kitchen
Fiesta single lever kitchen
Aquarian II lav & shower
Shower Thermo Guard
Aquarian kitchen
Aquarian lav
Tub/Shower
Tub/Shower

OEM 72547
61228
37982
70545
70613
77031
77033
10889
50081

LENGTH 4-1/2"
4-1/2"
5-3/4"
4"
4-1/8"
6-1/4"
4-1/2"
4-1/8"
3-3/8"

OTHER AM/STD HANDLES ARE AVAILABLE. PLEASE ORDER BY OEM NUMBER.

DELTA

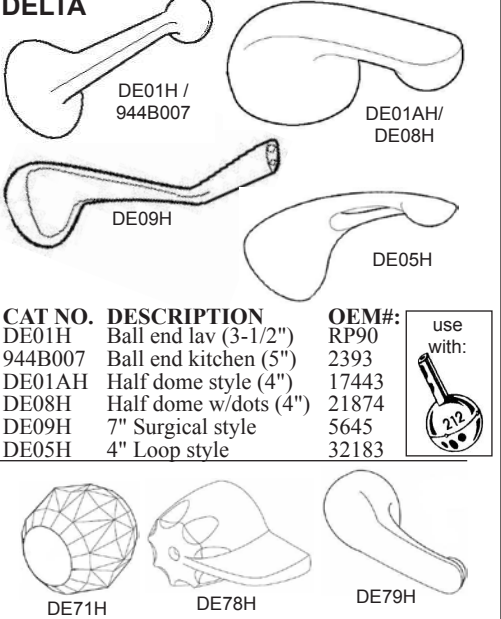

CAT NO. DE01H / 944B007
DE01AH / DE08H
DE09H
DE05H

DESCRIPTION
Ball end lav (3-1/2")
Ball end kitchen (5")
Half dome style (4")
Half dome w/dots (4")
7" Surgical style
4" Loop style

OEM#: RP90
2393
17443
21874
5645
32183

DE71H Round Knob
DE78H Wedge Handle
DE79H Lever Handle

use with:



INDIVIDUAL PARTS / FAUCET REPAIRS

SINGLE LEVER & KNOB FAUCET HANDLES (cont.)

ELJER

EJ01H
EJ05H
EJ04H

CAT NO.	DESCRIPTION	OEM
EJ05H	Lever style, 2001+	H116

ELKAY

EK01H

CAT NO.	DESCRIPTION	OEM
EK01H	Lever style,	53080

GERBER

See details for Gerber handles on page 1-50

KOHLER
Use these handles with THIS cartridge:

KO52H
KO51H
KO53H
KO54H

CAT NO.	DESCRIPTION	OEM
KO51H	Knob	77338
KO52H	Loop lever	1005588
KO53H	Long lever	1001795
KO54H	Lever	1001796

KOHLER
Use these handles with THIS cartridge:

KO56H
KO57H

CAT NO.	DESCRIPTION	OEM
KO55H	Knob	30416
KO56H	Lever, screw, insert	30423/71610
KO57H	Flat lever only	71535

MIXET

9MX0060
9MX0029
9MX0031
9MX0009
9MX0030
9MX0011

CAT NO.	DESCRIPTION	OEM
9MX0060	Loop temp handle	MLH-HH
9MX0029	Clear round handle	MRH-CLR
9MX0031	Clear temp handle	MTH-CLR
9MX0009	Metal round handle	MRH-MET
9MX0030	Metal temp. handle	MLH-MET
9MX0011	Plastic temp. handle	MLH-CP

MOEN
Use these handles with THIS cartridge:

MO06H
MO07H
MO0258
MO08H

LAV: SHORT INSERT SHOWER: LONG INSERT

CAT NO.	DESCRIPTION	OEM
MO06H	Economy Round knob (tub/shower)	
MO07H	Economy Round knob (lav)	
9MO0258	Oval knob for tub/shower	96797
MO08H	Economy version of above	
9MO0259	Oval knob for lav	13103
MO09H	Economy version of above	

MOEN
Use these handles with THIS cartridge:

MO02H
MO032H
MO039H
MO040H
MO02H
MO032H
MO039H
MO040H

CAT NO.	DESCRIPTION	OEM
MO02H	Lever for Chateau lav	13393
MO032H	Lever for Chateau shower	13499
MO039H	Lever for Chateau	100224
MO034H	Lever for Chateau	100657
MO040H	Lever for Chateau	94740

MOEN
Use these handles with THIS cartridge:

MO033H
MO034H
MO038H
MO037H

CAT NO.	DESCRIPTION	OEM
MO033H	Knob for Posi-temp	96884
MO034H	Lever for Posi-temp	100657
MO038H	Lever for Posi-temp	14732
MO037H	Lever for Moentrol	13291

PRICE PFISTER
Use these handles with THIS cartridge:

9PF1101
9PF1102
227C016
9PF1100

PF65H

9PF1103
9PF1104
9PF1100

PF66H

9PF1105
9PF1106
9PF1109
9PF1107

PF67H

9PF1105
9PF1106
9PF1109
9PF1108

PF68H

CAT NO.	DESCRIPTION	OEM
PF65H	Loop handle kit complete	disc.
PF66H	VP Loop handle kit complete	disc.
PF67H	Solid handle kit complete	
PF68H	Loop handle kit complete	disc.
9PF1100	Loop handle	940-145 disc.
9PF1101	Button insert	941-960
9PF1102	Label for button	941-970
9PF1103	Insert spacer	941-345
9PF1104	VP screw	971-966
9PF1105	Labels	940-805
9PF1106	Adapter screw	970-800
9PF1107	Solid handle	940-800
9PF1108	Loop handle	940-997 disc.
9PF1109	Set Screw	971-130
227C016	Handle screw	971-860



INDIVIDUAL PARTS / FAUCET REPAIRS

SINGLE LEVER & KNOB FAUCET HANDLES (cont.)

SAVOY

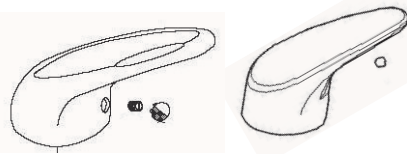

CAT NO.	DESCRIPTION	OEM
SV6011	Loop handle	X031515
121C049	Index for loop handle	
SV6012	Solid handle	X030516
	Index for solid handle	

SYMMONS

These handles are used on various Symmons lav faucets.



CAT NO.	FOR FAUCET:	OEM
947S669	S-20 Series (loop)	KN-3BRB
947S371	S-20 Series	LN-135
947S670	S-20 Series (solid)	KN-3RB
947S661	S-20 Series	LN-122
947S662	S-60 Scot 1984-2000	LL-18
947S663	S-60 Scot 2000+	LL-104
947S664	S-61 1994-2000	LT-37
947S665	S-61 2001+	LT-100
947S666	Temptrol 1974-1999	L-2

VALLEY

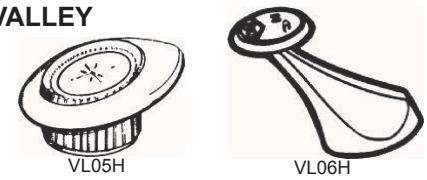

CAT NO.	DESCRIPTION:
VL05H	Lucite Handle
VL06H	Metal Handle

Notes:



SYMMONS

These handles are interchangeable on Symmons' Temptrol shower valves.

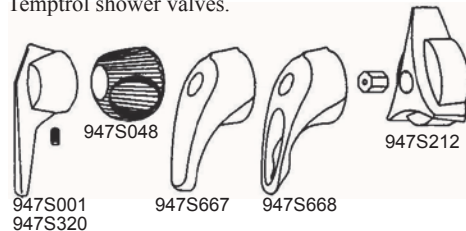

CAT NO.	DESCRIPTION	OEM
947S001	Lever handle (fits C-5)	(RC-14)
947S320	Lever handle (fits TA-10)	(RC-14X)
947S048	Knob handle	(T-101)
947S667	Lever handle	(T3-31S)
947S668	Lever handle	(T3-31L)
947S212	Triangle handle	(T-31)

FAUCET HANDLES

ACORN



HOT: **9AN0003**
COLD: **9AN0002**

SCREW: **9AN0001**

USED ON:
2 temperature
Flo-Cloz Valves

ACORN

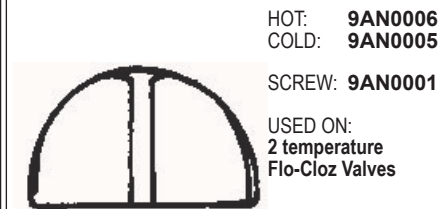

HOT: **9AN0006**
COLD: **9AN0005**

SCREW: **9AN0001**

USED ON:
2 temperature
Flo-Cloz Valves

Tip to Tip dimension: **2-3/8"**



ACORN



SINGLE: **9AN0004**

SCREW: **9AN0001**

USED ON:
SINGLE temperature
Flo-Clos valves

ACORN

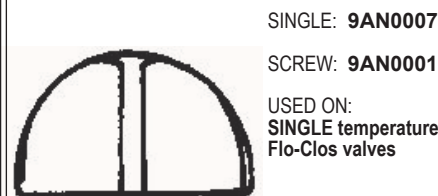

SINGLE: **9AN0007**

SCREW: **9AN0001**

USED ON:
SINGLE temperature
Flo-Clos valves

ACORN

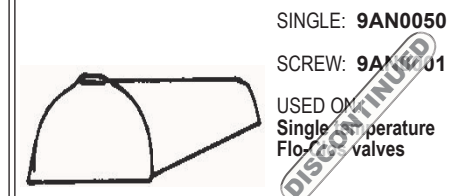

SINGLE: **9AN0050**

SCREW: **9AN0001**

USED ON:
SINGLE temperature
Flo-Clos valves

AMERICAN KITCHENS



PAIR: **AK01H**
HOT: **AK280**
COLD: **AK280**

USED ON:
LF100C Back Mount Sink

Tip to Tip dimension: **2-5/16"**

AMERICAN KITCHENS



PAIR: **AK02AH**
HOT: **AK288**
COLD: **AK288**

USED ON:
LF210 Back Mount Sink

Tip to Tip dimension: **2-1/8"**

AMERICAN KITCHENS

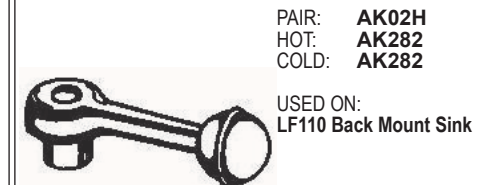

PAIR: **AK02H**
HOT: **AK282**
COLD: **AK282**











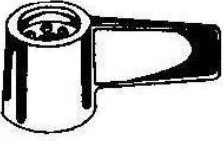



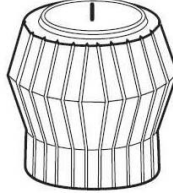
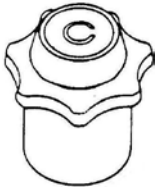

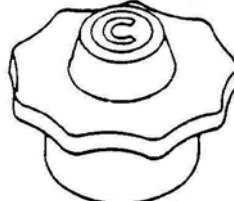

USED ON:
LF110 Back Mount Sink

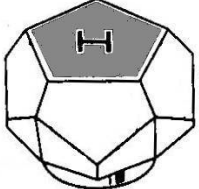
Tip to Tip dimension: **2-5/16"**

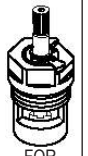
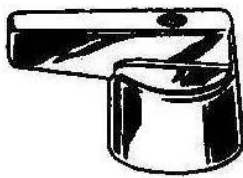

INDIVIDUAL PARTS / FAUCET REPAIRS

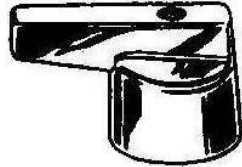
FAUCET HANDLES (cont.)

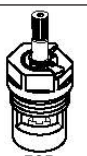
<p>AMERICAN STANDARD SINGLE: 9AS0395 CAP: 948A031 USED ON: Drinking fountains</p>  <p>Tip to Tip dimension: 2-5/8"</p>	<p>AMERICAN STANDARD PAIR: AS04H HOT: AS355 COLD: AS354 SCREW: 227C002</p>  <p>Tip to Tip dimension: 2"</p>	<p>AMERICAN STANDARD PAIR: AS03H HOT: AS353 COLD: AS352 SCREW: 227C002</p>  <p>Tip to Tip dimension: 2"</p>
<p>AMERICAN STANDARD PAIR: AS08H SCREW: 227C002 USED ON: R40 & R41 Ledge Sink Faucets</p>  <p>Tip to Tip dimension: 2-1/2"</p>	<p>AMERICAN STANDARD AS18AH (OEM Handle pair) AS18AHX (Economy Handle pair with adapters) SCREW: 227C002 USED ON: Colony Faucets</p>  <p>Tip to Tip dimension: 1-3/8"</p>	<p>AMERICAN STANDARD SINGLE: AS64H OEM: 68614 Base Diameter: 2" Tip to Tip dimension: 2-5/8"</p> 
<p>AMERICAN STANDARD PAIR: AS77HS SCREW: 227C002 USED ON: 4" Lavs & most kitchen faucets</p>   <p>FOR AQUASEAL</p> <p>Tip to Tip dimension: 2"</p>	<p>AMERICAN STANDARD PAIR: AS77H SCREW: 227C002 USED ON: Widespread lav faucets</p>   <p>FOR AQUASEAL</p> <p>Tip to Tip dimension: 2-1/4"</p>	<p>AMERICAN STANDARD PAIR: AS77HL SCREW: 227C002 USED ON: Shower valves</p>   <p>FOR AQUASEAL</p> <p>Tip to Tip dimension: 2-3/4"</p>
<p>AMERICAN STANDARD PAIR: AS57H SCREW: 227C002 USED ON: 4" Lavs</p>  <p>Tip to Tip dimension: 2-1/4"</p>	<p>AMERICAN STANDARD PAIR: AS67H DIV: AS67HD SCREW: 227C002 USED ON: Shower Valves</p>  <p>Tip to Tip dimension: 2-5/8"</p>	<p>AMERICAN STANDARD PAIR: AS88H EACH: AS178H USED ON: Lav faucets w/ ceramic cartridges</p>   <p>FOR CERAMICS</p>
<p>AMERICAN STANDARD PAIR: AS13H HOT: AS363 COLD: AS362 DIV: 9AS4321 SCREW: 227C002 USED ON: R-4000 series faucets, R-2100 slant back (non- renu), and shower valves.</p>  <p>Base Diameter: 1-3/8" Tip to Tip dimension: 2-3/8"</p>	<p>AMERICAN STANDARD SINGLE: AS63H OEM: 50074 Height: 2-1/2" Tip to Tip dimension: 2-1/2"</p> 	<p>AMERICAN STANDARD PAIR: AS71H (oem 142H) USED ON: Above Deck Faucets PAIR: AS72H (oem 342H) USED ON: Below Deck Faucets</p> 
<p>AMERICAN STANDARD PAIR: AS07H HOT: AS359 COLD: AS358 SCREW: 227C002 USED ON: R-4100 series ledge sink faucets (non-renu)</p>  <p>Base Diameter: 1-1/2" Tip to Tip dimension: 2-1/4"</p>	<p>AMERICAN STANDARD PAIR: AS07HX (Economy Handle pair with adapters) SCREW: 227C002 USED ON: R-4100 series ledge sink faucets (non-renu)</p>  <p>Base Diameter: 1-1/2" Tip to Tip dimension: 2-1/4"</p>	<p>AMERICAN STANDARD PAIR: AS65H (oem 152H) USED ON: Above Deck Faucets</p>   <p>FOR CERAMICS</p>



INDIVIDUAL PARTS / FAUCET REPAIRS

FAUCET HANDLES (cont.)

AMERICAN STANDARD

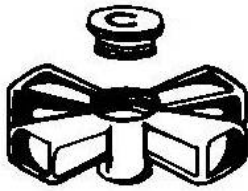

PAIR: **AS12H**
DIV: **AS12HD**

SCREW: **227C002**

HOT INDEX: **939C004**
COLD INDEX: **939C003**
BLANK INDEX: **9AS0827**

USED ON:
Showers & Widespreads

Tip to Tip dimension: **2-3/4"**

AMERICAN STANDARD

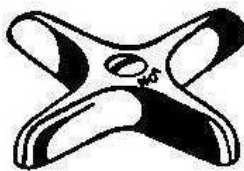

PAIR: **AS12AH**
(economy pair)

SCREW: **227C002**

USED ON:
Showers & Widespreads

Tip to Tip dimension: **2-1/2"**

AMERICAN STANDARD



SINGLE: **948A028**

CAP: **948A031**

USED ON:
Drinking Fountains

Tip to Tip dimension: **2-13/16"**

AMERICAN STANDARD



PAIR: **AS36H**

SCREW: **227C002**

HOT INDEX: **121C075**
COLD INDEX: **121C076**

USED ON:
Colony Bath & Shower

Tip to Tip dimension: **3"**

AMERICAN STANDARD

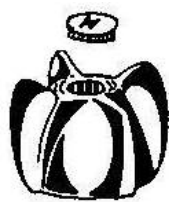

PAIR: **AS18H**

SCREW: **227C002**

HOT INDEX: **121C075**
COLD INDEX: **121C076**

USED ON:
Colony Lav Faucets

Tip to Tip dimension: **2-1/16"**

AMERICAN STANDARD



EACH: **9AS9623**
(Metering Handle with set screw and indexes)

INDEXES & SET SCREW: **9AS6239**

USED ON:
Push button metering faucets

9AS9623

AMERICAN STANDARD

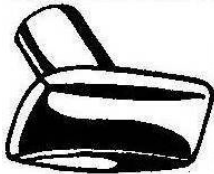

SINGLE: **9AS2622**

SCREW: **9AS2650**

USED ON:
Push-Pull Shower Valves

Side to Side dimension: **3"**

AMERICAN STANDARD



Old style Push-Pull shower handle, replaced by 9AS2622

AMERICAN STANDARD



PAIR: **AS35H**

HOT: **AS365**
COLD: **AS364**

DIV: **AS35HD**

SCREW: **227C002**

USED ON:
Traciline Bath and shower valves

Tip to Tip dimension: **2-5/8"**

AMERICAN STANDARD



Old style Push-Pull shower handle, replaced by 9AS1473

AMERICAN STANDARD



SINGLE: **9AS1473**

INDEX: **121C057**

USED ON:
Push-Pull Lavs

Side to Side dimension: **2"**

AMERICAN STANDARD



HOT: **9AS2083**
COLD: **9AS2082**

SCREW: **9AS2650**

USED ON:
Self Closing Metering

Side to Side dimension: **1-1/4"**

AMERICAN STANDARD

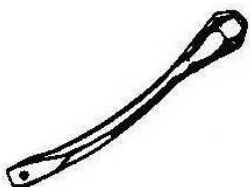

SINGLE: **941C003**

USED ON:
Single Lever Lav

Tip to Tip dimension: **4-1/2"**

AMERICAN STANDARD

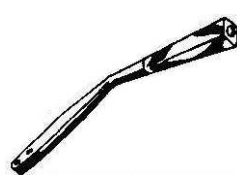

SINGLE: **9AS4118**

USED ON:
Single Control Sinks

Tip to Tip dimension: **5-3/4"**

INDIVIDUAL INDEXES
ARE SHOWN ON
PAGES 1-62 - 1-64

MEASURE LIKE THIS:

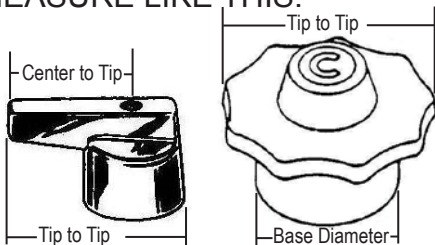



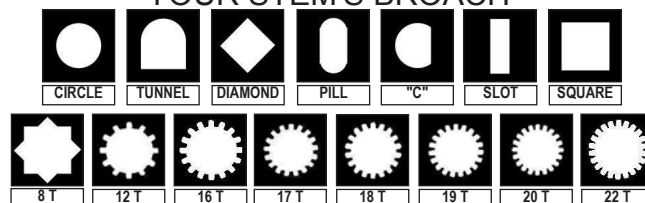





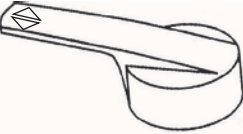



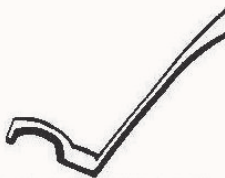

USE THIS CHART TO IDENTIFY YOUR STEM'S BROACH

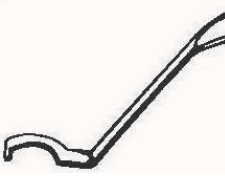

INDIVIDUAL PARTS / FAUCET REPAIRS

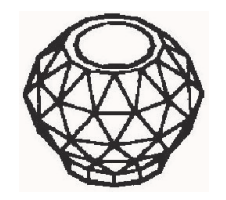

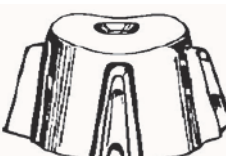



FAUCET HANDLES (cont.)

<p>AMERICAN STANDARD SINGLE: 9AS4659 USED ON: Aquarian II Lav & Shower OEM: 70545</p>  <p>Tip to Tip dimension: 4"</p>	<p>AMERICAN STANDARD SINGLE: AS82H USED ON: Aquarian Lav OEM: 77033</p>  <p>Tip to Tip dimension: 3-1/4"</p>	<p>AMERICAN STANDARD SINGLE: AS81H USED ON: Aquarian Shower OEM: 77031</p>  <p>Tip to Tip dimension: 5"</p>
<p>AMERICAN STANDARD SINGLE: 9AS3416 USED ON: Fiesta Kitchen OEM: 37982</p>  <p>Tip to Tip dimension: 5-3/4"</p>	<p>AMERICAN STANDARD SINGLE: AS87H USED ON: Tub & Shower OEM: 10889</p>  <p>Tip to Tip dimension: 4-1/8"</p>	<p>AMERICAN STANDARD SINGLE: AS89H USED ON: Tub & Shower OEM: 50081</p>  <p>Tip to Tip dimension: 3-3/8"</p>
<p>AMERICAN STANDARD SINGLE: 9AS6054 USED ON: Thermoguard Tub & Shower OEM: 70613</p>  <p>Tip to Tip dimension: 4-1/8"</p>	<p>BRADLEY-COLE SINGLE: 928C401 USED ON: Sceptre & Cascade kitchen faucets</p>  <p>Tip to Tip dimension: 5-3/4"</p>	<p>BRADLEY-COLE SINGLE: 928C410 INDEX: 928C410 SCREW: 227C008 USED ON: Sceptre & Cascade kitchen, lav, and bath faucets</p>  <p>Center to Tip dimension: 1-3/8"</p> <p>USE 928C426</p>
<p>BRADLEY-COLE SINGLE: 928C426 USED ON: Single lever kitchen, lav, and bath faucets</p>  <p>Center to Tip dimension: 1-1/2"</p>	<p>BRADLEY-COLE SINGLE: 928C400 USED ON: Sceptre & Cascade lav faucets</p>  <p>Tip to Tip dimension: 4-5/8"</p>	<p>BRIGGS PAIR: BR01H HOT: BR893 COLD: BR892 SCREW: 227C008</p>  <p>Center to Tip dimension: 2-5/8"</p>
<p>BRIGGS / SAYCO PAIR: BR04H HOT: BR891 COLD: BR890 SCREW: 227C008 USED ON: T-9220 Back mount sink</p>  <p>Center to Tip dimension: 2-1/4"</p>	<p>BRIGGS / SAYCO PAIR: BR10H HOT: BR897 COLD: BR896 SCREW: 227C008 USED ON: t-880, 8805, 8820 series lav faucets</p>  <p>Center to Tip dimension: 2-1/4"</p>	<p>BRIGGS / SAYCO PAIR: SC36H HOT: SC6971 COLD: SC6970 SCREW: 227C008 USED ON: 4" Lavs & most kitchen faucets</p>  <p>Height: 2-1/4" Tip to Tip dimension: 1-3/4"</p>
<p>BRIGGS / SAYCO PAIR: BR30H DIV: BR30HD H INDEX: 939C003 C INDEX: 939C004 USED ON: Lav and shower valves</p>  <p>Tip to Tip dimension: 3"</p>	<p>BRIGGS / SAYCO PAIR: BR30AH (economy pair) USED ON: Lav and shower valves</p>  <p>Tip to Tip dimension: 2-1/2"</p>	<p>BRIGGS / SAYCO HOT: BR903 COLD: BR904 (similar to picture) USED ON: Trimline shower valves</p> 

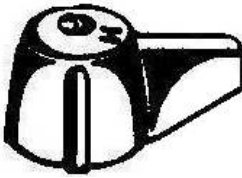

INDIVIDUAL PARTS / FAUCET REPAIRS

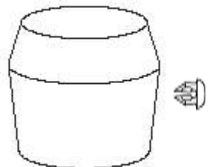
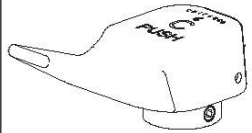

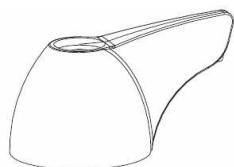























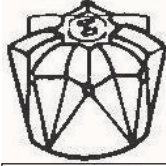

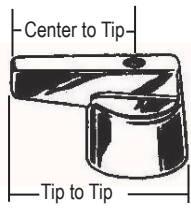

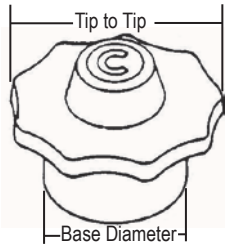

FAUCET HANDLES (cont.)

<p>BROADWAY</p>  <p>SINGLE: 9BW0001 (CP) 9BW0005 (PB)</p> <p>USED ON: Broadway and T&S Brass faucets</p>	 <p>FLANGE: 9BW0002 (PB) RING: 9BW0003 (PB)</p> <p>USED ON: Broadway and T&S Brass faucets</p> <p>FLANGE & RING TOGETHER</p>	<p>CENTRAL BRASS</p>  <p>PAIR: CB06H HOT: CB11055 COLD: CB11054</p> <p>SCREW: 227C008</p> <p>Center to Tip dimension: 1-3/4"</p>
<p>CENTRAL BRASS</p>  <p>PAIR: CB07H</p> <p>SCREW: 227C008</p> <p>USED ON: Superseat sinks and old model faucets</p> <p>Center to Tip dimension: 1-3/4"</p>	<p>CENTRAL BRASS</p>  <p>PAIR: CB30H DIV: CB30HD</p> <p>SCREW: 227C008</p> <p>USED ON: Shower and bath valves</p> <p>Tip to Tip dimension: 2-3/4"</p>	<p>CENTRAL BRASS</p>  <p>PAIR: CB05H</p> <p>SCREW: 227C008</p> <p>USED ON: Ledge and concealed sink faucets</p> <p>Center to Tip dimension: 2-3/16"</p>
<p>CENTRAL BRASS</p>  <p>PLAIN: 949I215 HOT: 949I214 COLD: 949I213</p> <p>SCREW: 227C008</p> <p>USED ON: Push-on faucets</p>	<p>CENTRAL BRASS</p>  <p>HOT: CB11060 COLD: CB11059</p> <p>SCREW: 227C008</p> <p>USED ON: Widespread Lav</p> <p>Tip to Tip dimension: 3"</p>	<p>CENTRAL BRASS</p>  <p>PAIR: CB04H</p> <p>SCREW: 227C008</p> <p>USED ON: Lav, Bath, Shower</p>
<p>CENTRAL BRASS</p>  <p>PAIR: CB34H</p> <p>SCREW: 227C008</p> <p>USED ON: Lav, Bath, Shower</p> <p>Tip to Tip dimension: 1-15/16"</p>	<p>CHICAGO FAUCET</p>  <p>PAIR: CF01H</p> <p>RED RING: 9CF0578 BLUE RING: 9CF0580</p> <p>SCREW: 227C008</p> <p>USED ON: All Chicago faucets</p> <p>Tip to Tip dimension: 2-1/4"</p>	<p>CHICAGO FAUCET</p>  <p>PAIR: CF03H</p> <p>RED RING: 9CF0578 BLUE RING: 9CF0580</p> <p>SCREW: 227C008</p> <p>USED ON: All Chicago faucets</p>
<p>CHICAGO FAUCET</p>  <p>PLAIN: 949F219 (includes red, blue, and white buttons)</p> <p>SET OF COLORED BUTTONS: 9CF3360</p> <p>USED ON: MVP Cartridges</p>	 <p>ALL HANDLES PACKED WITH SCREWS & INDEXES (WHERE APPLICABLE)</p>	<p>CHICAGO FAUCET (DUCK BILL)</p>  <p>HOT: 9CF3358 COLD: 9CF3357 PLAIN: 9CF3359</p> <p>USED ON: 335X Cartridges (9CF1007)</p>
<p>CHICAGO FAUCET</p>  <p>PAIR: CF02H</p> <p>COLD: CF1230 HOT: CF1231</p> <p>SCREW: 227C008</p> <p>USED ON: All Chicago faucets</p>	<p>CHICAGO FAUCET</p>  <p>PAIR: CF07H</p> <p>SCREW: 227C008</p> <p>USED ON: New style and old style faucets</p>	<p>CHICAGO FAUCET (TIP TAP)</p>  <p>HOT: 9CF0353 COLD: 9CF0357 PLAIN: 9CF0358</p> <p>USED ON: 335X Cartridges (9CF1007)</p>



INDIVIDUAL PARTS / FAUCET REPAIRS

FAUCET HANDLES (cont.)

<p>CRANE</p> <p>PAIR: CR03H</p> <p>HOT: CR16002⁽⁹⁰⁴³⁾ COLD: CR16003⁽⁹⁰⁴⁴⁾</p> <p>SCREW: 227C015</p> <p>USED ON: Capri faucets</p>  <p>USE WITH </p> <p>Center to Tip dimension: 1-11/16"</p> <p>OLD STYLE </p>	<p>CRANE</p> <p>PAIR: CR03HX (Economy handle pair with adapters)</p> <p>SCREW: 227C015</p> <p>USED ON: Capri faucets</p>  <p>USE WITH </p> <p>Center to Tip dimension: 1-11/16"</p> <p>OLD STYLE </p>	<p>CRANE</p> <p>PAIR: CR04H</p> <p>HOT: CR16017⁽⁹⁰⁴⁵⁾ COLD: CR16018⁽⁹⁰⁴⁶⁾</p> <p>SCREW: 227C015</p> <p>USED ON: Capri faucets</p>  <p>USE WITH </p> <p>Center to Tip dimension: 2"</p> <p>OLD STYLE </p>
<p>CRANE</p> <p>PAIR: CR30H (16797cl 16795h)</p> <p>SCREW: 226C002</p> <p>USED ON: Riviera lav faucets</p>  <p>Base Diameter: 1-7/8"</p>	<p>CRANE</p> <p>HOT: 9CR2010⁽¹⁶⁷⁹⁹⁾ COLD: 9CR2011⁽¹⁶⁸⁰¹⁾</p> <p>SCREW: 226C002</p> <p>USED ON: Riviera widespread faucets</p>  <p>Base Diameter: 2-1/8"</p>	<p>CRANE</p> <p>PAIR: CR31H</p> <p>HOT: 9CR2060⁽¹⁷⁶³⁴⁾ GOLD: 9CR2061⁽¹⁷⁶³⁴⁾ DIV: 9CR2015⁽¹⁶⁸¹⁰⁾ (3/8" diameter broach)</p> <p>SCREW: 226C002</p> <p>USED ON: Riviera bath and shower</p>  <p>Base Diameter: 2-1/2"</p>
<p>CRANE</p> <p>PAIR: CR32H</p> <p>HOT: CR16031⁽⁸³⁷⁴⁾ COLD: CR16032⁽⁸³⁷⁵⁾</p> <p>H INDEX: 121C059 C INDEX: 121C058 BLANK INDEX: 9CR1168</p> <p>USED ON: Hospital lav, bath, and shower</p>  <p>USE WITH </p> <p>Tip to Tip dimension: 2-3/4"</p>	<p>CRANE</p> <p>SINGLE: 9CR1466⁽⁹⁰⁶²⁾</p> <p>USED ON: Magic-close faucets</p>  <p>Base Diameter: 1-5/8"</p>	<p>CRANE</p> <p>PAIR: 9CR2014 (1/2" diameter broach)</p> <p>SCREW: 226C002</p> <p>USED ON: Riviera bath and shower</p>  <p>Base Diameter: 2-1/2"</p>
<p>CRANE</p> <p>HOT: 9CR2429⁽¹¹³⁶⁴⁾ COLD: 9CR2430⁽¹¹³⁶⁵⁾</p> <p>H INDEX: 121C093 C INDEX: 121C094</p> <p>USED ON: Riviera lav faucets</p>  <p>Tip to Tip dimension: 2-5/16"</p>	<p>CRANE</p> <p>USE: 9CR2378 / 79 HOT: 9CR2432⁽¹⁷⁰⁴⁷⁾ GOLD: 9CR2431⁽¹⁴³⁶⁹⁾ DIV: 9CR2433⁽¹⁶⁸¹⁰⁾</p> <p>H INDEX: 121C093 C INDEX: 121C094</p> <p>USED ON: Riviera bath and shower</p>  <p>Replaced with 5 wing handle </p> <p>Tip to Tip dimension: 2-7/8"</p>	<p>MEASURE LIKE THIS:</p>  <p>Center to Tip Tip to Tip</p>
<p>CRANE</p> <p>HOT: 9CR2524⁽¹¹⁰⁶⁷⁾ COLD: 9CR2525⁽¹¹⁰⁶⁸⁾</p> <p>H INDEX: 121C063 C INDEX: 121C062</p> <p>USE WITH </p> <p>Base Diameter: 1-7/16"</p> 	<p>CRANE</p> <p>USE: 9CR2378 / 79 HOT: 9CR2522⁽¹¹⁰⁶⁵⁾ GOLD: 9CR2523⁽¹¹⁰⁶⁶⁾</p> <p>H INDEX: 121C063 C INDEX: 121C062</p> <p>USE WITH </p> <p>Replaced with 5 wing handle </p> <p>Base Diameter: 1-3/4"</p> 	 <p>Tip to Tip Base Diameter</p>
<p>CRANE</p> <p>USE: 9CR1466 HOT: 9CR1838⁽¹⁴⁸¹⁶⁾ GOLD: 9CR1839⁽¹⁴⁸¹⁷⁾</p> <p>SCREW: 226C002</p> <p>USED ON:</p> <p>Replaced with X top handle </p> <p>USE WITH </p> <p>Tip to Tip dimension: 1-1/2"</p> 	<p>CRANE</p> <p>HOT: 9CR2378⁽⁹⁴⁰¹⁾ COLD: 9CR2379⁽⁹⁴⁰²⁾</p> <p>SCREW: 226C002</p> <p>USED ON: Capri widespread faucets</p> <p>USE WITH </p> <p>Tip to Tip dimension: 1-3/4"</p> 	<p>CRANE</p> <p>SINGLE: 9CR1914⁽¹⁵¹⁷⁵⁾</p> <p>SCREW: 227C007</p> <p>USED ON: Dialette lav faucets  (with this cartridge)</p> <p>Tip to Tip dimension: 1-3/4"</p> 



INDIVIDUAL PARTS / FAUCET REPAIRS

FAUCET HANDLES (cont.)

CRANE



HOT: **9CR1655**⁽¹⁴¹⁶⁰⁾
COLD: **9CR1654**⁽¹⁴¹⁵⁹⁾

SCREW: **227C015**

USED ON:
Riviera lav faucets
(16 point broach only)

Tip to Tip dimension: 3"

CRANE



HOT: ~~**9CR1864**~~⁽¹⁴⁴⁵²⁶⁾
GOLD: ~~**9CR1862**~~⁽¹⁴⁴⁹⁹³⁾

SCREW: **227C015**

USED ON:
Riviera lav faucets

CRANE



USE: **CR31H**
PAIR: ~~**CR37H**~~
HOT: ~~**9CR1863**~~⁽¹⁴⁴⁹⁹⁵⁾
GOLD: ~~**9CR1864**~~⁽¹⁴⁴⁹⁹⁷⁾

SCREW: **227C015**

USED ON:
Riviera bath & shower

CRANE

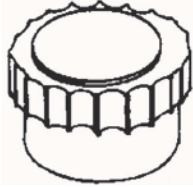

HOT: **9CR2526**⁽¹¹⁰⁷²⁾
COLD: **9CR2527**⁽¹¹⁰⁷²⁾

SCREW: **227C010**

USED ON:
Crestmont lav faucets

Tip to Tip dimension: 2"

CRANE



PAIR: **CR33H**
HOT: **CR16023**⁽¹⁴⁵³⁶⁾
COLD: **CR16027**⁽¹⁴⁵³⁷⁾

SCREW: **227C010**

USED ON:
Crestmont lav faucets

Tip to Tip dimension: 2"

CRANE



PAIR: **CR34H**
HOT: **9CR1788**⁽¹⁴⁵³⁴⁾
COLD: **9CR1789**⁽¹⁴⁵³⁵⁾

SCREW: **227C015**

USED ON:
Crestmont bath & shower

Tip to Tip dimension: 2-3/4"

CRANE



HOT: **9CR2239**⁽⁸³⁹¹⁾
COLD: **9CR2240**⁽⁸³⁹²⁾

CRANE

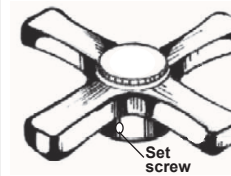

HOT: **9CR2258**⁽⁸⁵¹⁷⁾
COLD: **9CR2259**⁽⁸⁵¹⁸⁾

CRESTLINE

Every kit includes either hot & cold, or diverter handle, plus: matching brass broach inserts, screws, & porcelain buttons.



CRESTLINE



PAIR: **CT01H**

USED ON:
Crestline commercial mop sink faucets

CRESTLINE



SINGLE: **CL10H**

USED ON:
Crestline Delex style single handled lav

Tip to Tip dimension: 2-3/4"

H & C

CAT NO:
VP601
VP602
VP603
VP604
VP605
VP606
VP607
VP608
VP609
VP610

DIVERTER

CAT NO:
VP651
VP652
VP653
VP654
VP655
VP656
VP657
VP658
VP659
VP660

MFR:
American Std
Briggs
Central Brass
Chicago
Gerber
Kohler
Price Pfister
Repcal
Savoy
Sayco

CRESTLINE



SINGLE: **CL01H**

USED ON:
Crestline Delex style single handled lav

Base Diameter: 1-3/4"
Tip to Tip dimension: 4"

CRESTLINE



SINGLE: **CL03H**

USED ON:
Crestline Delex style single handled kitchen

Base Diameter: 1-7/8"
Tip to Tip dimension: 5-3/8"

From this...



To this...



CRESTLINE



PAIR: **CL02H**
HOT: **CL3001**
COLD: **CL3002**

USED ON:
Crestline Delex style 2 handled lav and kitchen

CRESTLINE



PAIR: **CL96H**
PAIR: ~~**CL96H**~~ CARTRIDGES: **CL96HX**

USED ON:
Crestline Deco style 2 handled lav and kitchen

Center to Tip dimension: 3"

Note: Must be used with cartridges shown at right.

CRESTLINE

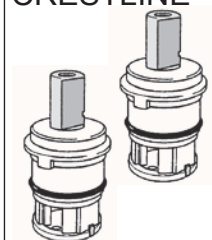

H & H: **CL96ATG**
H & C: **CL96TG**











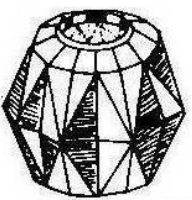

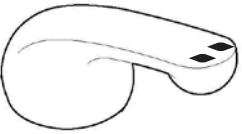

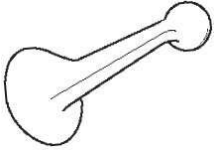
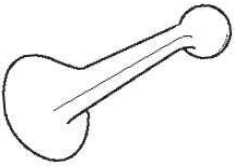
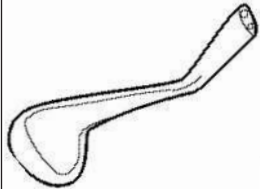
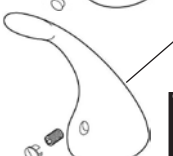
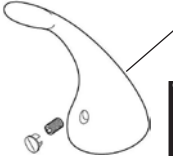

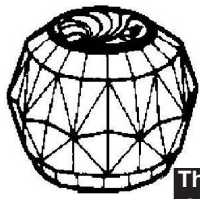
USED ON:
Crestline Deco style 2 handled lav and kitchen

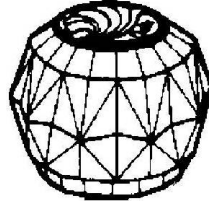
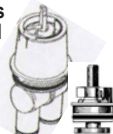
Note: These cartridges have integrated stops to keep handles from free spinning. Use with CL96H handles







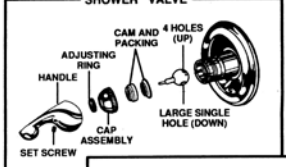
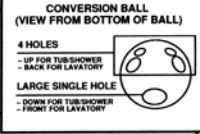
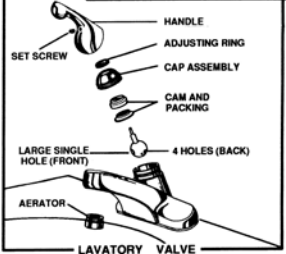





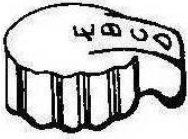

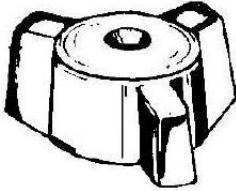
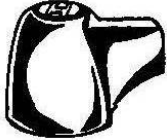



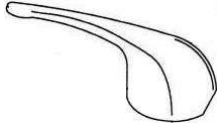

INDIVIDUAL PARTS / FAUCET REPAIRS

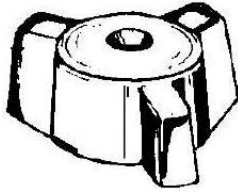
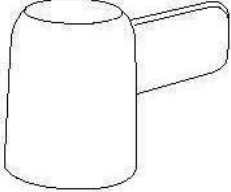
FAUCET HANDLES (cont.)

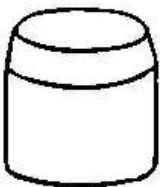
<p>DELTA</p>  <p>PAIR: DX01H (oem H28)</p> <p>USED ON: 2 handled Lav and kitchen faucets</p>	<p>DELTA</p>  <p>PAIR: 944B088 (oem RP2390/H41)</p> <p>USED ON: 2 handled widespread faucets</p> <p>Tip to Tip dimension: 2-1/4"</p>	<p>DELTA</p>  <p>PAIR: DX02H (oem H21)</p> <p>USED ON: 2 handled Lav and kitchen faucets</p>
<p>DELTA</p>  <p>SINGLE: DE05H (Loop style) (oem RP32183)</p> <p>USED ON: Lav and kitchen faucets</p> <p>Tip to Tip dimension: 5-1/4"</p>	<p>DELTA</p>  <p>SINGLE: DE08H (Half Dome Style, with red & blue dots) (oem RP21874)</p> <p>SINGLE: DE01AH (Half Dome Style, less dots) (oem RP17743)</p> <p>USED ON: Lav faucets</p> <p>Tip to Tip dimension: 4"</p>	<p>DELTA</p>  <p>PLAIN: DE32HP (oem RP5212)</p> <p>USED ON: Push valves using this cartridge:</p> 
<p>DELTA</p>  <p>SINGLE: DE01H (Loop style) (oem RP90)</p> <p>USED ON: Lav and kitchen faucets</p> <p>Tip to Tip dimension: 3-5/8"</p>	<p>DELTA</p>  <p>SINGLE: 944B007 (Dome Style) (oem RP2393)</p> <p>USED ON: Kitchen faucets</p> <p>Tip to Tip dimension: 5-1/4"</p>	<p>DELTA</p>  <p>SINGLE: DE09H (Surgical, with red & blue dots) (oem RP5645)</p> <p>USED ON: Surgical and kitchen faucets</p> <p>Tip to Tip dimension: 7"</p>
<p>DELTA</p>  <p>SINGLE: DE11H (oem RP42986) for LAV faucets</p>  <p>SINGLE: DE12H (oem RP44476) for KITCHEN faucets</p> <p>These handles are used with this ball.</p> 	<p>DELTA</p>  <p>SINGLE: DE1818 (oem RP2391) for SHOWER valves</p>  <p>SINGLE: DE10H (oem RP2389) for LAV faucets</p> <p>These handles are used with this ball.</p> 	<p>DELTA</p>  <p>SINGLE: DE71 (Lucite ball) (oem H71 / RP2392)</p> <p>USED ON: Shower valves 1300/1400 and Scald-Guard series</p> 
<p>DELTA</p>  <p>SINGLE: DE78H (Lever Canopy) (oem H78)</p>  <p>SINGLE: DE79H (Half Dome Style) (oem H79)</p>  <p>SINGLE: DE71H (Acrylic Ball Style) (oem H79)</p> <p>These three handles are ONLY for use with these cartridges.</p>  	<p>Convert Lucite Handle Delta faucets to Lever Handles</p> <p>Turn this...</p>  <p>...into this:</p>  <p>Use this special conversion ball to convert any Delta Faucet with an acrylic knob to an ADA approved lever handled faucet.</p>  <p>CAT NO: 944B022 OEM: RP20111</p> <div style="border: 1px solid black; padding: 5px;"> <p>SHOWER VALVE</p>  <p>CONVERSION BALL (VIEW FROM BOTTOM OF BALL)</p>  <p>LAVATORY VALVE</p>  </div>	

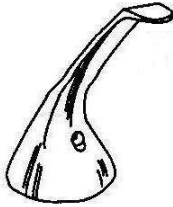
INDIVIDUAL PARTS / FAUCET REPAIRS

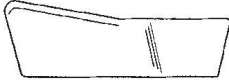
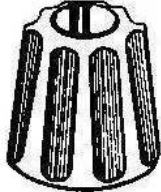

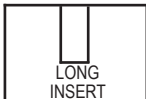







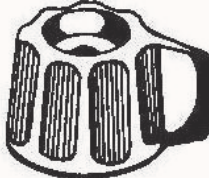





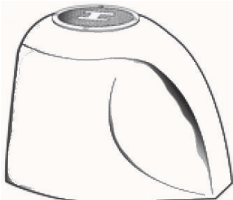

FAUCET HANDLES (cont.)

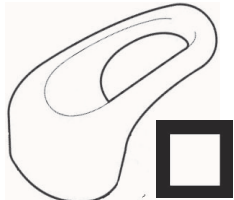
<p>EBCO</p>  <p>SINGLE: EB01H (Includes set screw)</p> <p>USED ON: Drinking Fountains</p> <p>Tip to Tip dimension: 1-3/4"</p>	<p>ELJER</p>  <p>PAIR: CB05H (also used on Central Brass Faucets)</p> <p>SCREW: 227C008</p> <p>USED ON: 2 handled Lav and kitchen faucets</p> <p>Tip to Tip dimension: 2-3/16"</p>	<p>ELJER</p>  <p>PAIR: EJ06H (OEM Pair)</p> <p>SCREW: 227C006</p> <p>USED ON: Lusterline 2 handled Lav and kitchen faucets</p>
<p>ELJER</p>  <p>PAIR: EJ03H</p> <p>HOT: EJ2183 (490-6375-01) COLD: EJ2182 (490-6376-02)</p> <p>SCREW: 227C002</p> <p>USED ON: 2 handled lavy faucets</p>	<p>ELJER</p>  <p>PAIR: EJ13H DIV: EJ31HD (490-6374-03)</p> <p>HOT: EJ6372 (490-6372-01) COLD: EJ6373 (490-6373-02)</p> <p>SCREW: 227C002</p> <p>USED ON: 2 handled kitchen and shower valves</p>	<p>ELJER</p>  <p>PAIR: CB04H (also used on Central Brass Faucets)</p> <p>SCREW: 227C002</p> <p>USED ON: 2 handled Lav, bath, and shower valves</p>
<p>ELJER</p>  <p>HOT: EJ2241 COLD: EJ2242 (OEM 490-8096)</p> <p>SCREW: 227C002</p>  <p>(Former style)</p>	<p>ELJER</p>  <p>PAIR: EJ21H</p> <p>HOT: EJ2184 COLD: EJ2185 (OEM 490-9069)</p> <p>USED ON: 2 handled Lav and kitchen faucets</p>	<p>ELJER</p>  <p>SINGLE: EJ05H (oem H116)</p> <p>USED ON: Single handled Lav and kitchen faucets AFTER 2001</p>
<p>ELJER</p>  <p>PAIR: EJ31H DIV: EJ31HD</p> <p>SCREW: 227C007</p> <p>USED ON: 2 and 3 handled shower valves</p>	<p>ELJER</p>  <p>PAIR: EJ06HX (Economy Handle pair with adapters)</p> <p>SCREW: 227C006</p> <p>USED ON: Lusterline 2 handled Lav and kitchen faucets</p>	<p>ELKAY</p>  <p>SINGLE: 9EK0017</p> <p>USED ON: Drinking Fountain shown below:</p> 
<p>ELKAY</p>  <p>SINGLE: 9EK0011</p> <p>USED ON: Drinking Fountain shown below:</p> 	<p>ELKAY</p>  <p>PAIR: EK01H (oem 53080)</p> <p>USED ON: Single handled Lav and kitchen faucets</p>	<p>FISHER-WESTERN</p>  <p>SINGLE: 937C128 (Includes screw & hot and cold buttons)</p> <p>SINGLE: 937C080 (Handle only, with NO screw or button)</p> <p>SCREW: 227C007</p>
<p>FISHER</p>  <p>SINGLE: 937F051 (Includes screw & hot and cold buttons)</p> <p>SINGLE: 937C086 (Handle only, with NO screw or button)</p> <p>SCREW: 227C007</p> <p>RED RING: 121C017 BLUE RING: 121C016</p>	<p>GERBER</p>  <p>PAIR: GB31H (Use with threaded sleeve)</p> <p>USED ON: 2 handled showers with threaded sleeve</p>  <p>SHORT INSERT</p>	<p>GERBER</p>  <p>PAIR: GB32H DIVERTER: GB2579 (Use with sliding sleeve)</p> <p>USED ON: 2 handled showers with sliding sleeve</p>  <p>LONG INSERT</p>

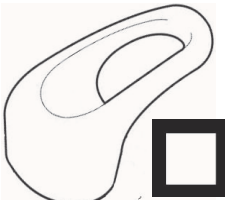

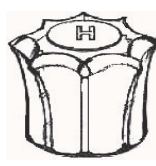
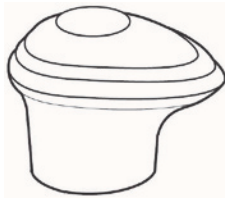
INDIVIDUAL PARTS / FAUCET REPAIRS











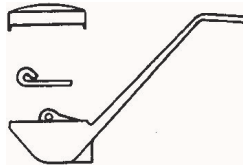

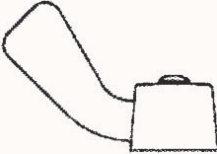
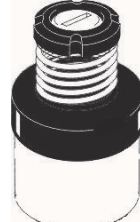

FAUCET HANDLES (cont.)

<p>GERBER</p>  <p>PAIR: GB10H</p> <p>USED ON: 2 handled old style lav and kitchen faucets</p> <p>Center to Tip dimension: 1-5/16"</p>	<p>GERBER</p>  <p>PAIR: GB33H</p> <p>USED ON: 2 handled old style bath and showers</p>	<p>Notes:</p> 
<p>GERBER</p>  <p>PAIR: GB30H (OEM pair)</p> <p>USED ON: Old style 2 handled bath and shower valves</p> <p>Tip to Tip dimension: 2-3/4"</p>	<p>GERBER</p>  <p>PAIR: GB04H (OEM pair)</p> <p>USED ON: Old style 2 handled lav and kitchen faucets</p> <p>Center to Tip dimension: 1-5/16"</p>	<p>GERBER</p>  <p>PAIR: GB04HX (Economy Handle pair with adapters)</p> <p>USED ON: Old style 2 handled lav and kitchen faucets</p>
<p>GERBER</p>  <p>PAIR: GB07H (OEM 60-000) (small)</p> <p>Hot Index: 121C251 Cold Index: 121C252 H&C Indexes: 121C032</p>	<p>GERBER</p>  <p>PAIR: GB17H (OEM 60-003) (large)</p> <p>USED ON: 2 handled new style kitchen & lav faucets</p>	<p>GERBER</p>  <p>HOT: 9GB0112 COLD: 9GB0113</p> <p>USED ON: Old style concealed sink and shower stall</p>
<p>GERBER</p>  <p>PAIR: GB05H (OEM 50-000) (small)</p> <p>USED ON: 2 handle lav and kitchen</p>	<p>GERBER</p>  <p>PAIR: GB16H (OEM 50-003) (large)</p> <p>USED ON: 2 handle lav and kitchen</p>	<p>GERBER</p>  <p>SINGLE: 960A247</p> <p>USED ON: Easy-Mix lav faucets 1982+</p>
<p>GERBER</p>  <p>SINGLE: GB11H (OEM 98-512)</p> <p>USED ON: Loop handle lav and kitchen</p>	<p>GERBER</p>  <p>SINGLE: GB12H (OEM 97-020)</p> <p>USED ON: Loop handle bath and shower (Safetemp)</p> 	<p>GERBER</p>  <p>SINGLE: GB13H (OEM 97-021)</p> <p>USED ON: Loop handle bath and shower (Hardwater Series)</p> 
<p>GERBER</p>  <p>PAIR: GB08H (OEM 98-425 & 98-426) (Lucite)</p> <p>USED ON: 2 handle kitchen</p>	<p>GERBER</p>  <p>SINGLE: GB14H (OEM 97-031)</p> <p>USED ON: Egg handle bath and shower (Safetemp)</p> 	<p>GERBER</p>  <p>SINGLE: GB15H (OEM 97-061)</p> <p>USED ON: Loop handle bath and shower (Hardwater Series)</p> 



INDIVIDUAL PARTS / FAUCET REPAIRS



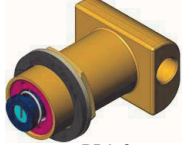
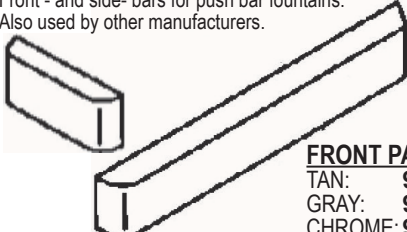





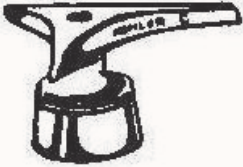
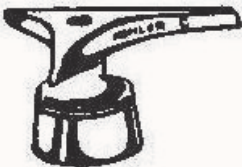
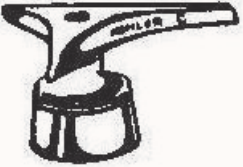
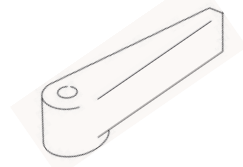

FAUCET HANDLES (cont.)

<p>GERBER</p>  <p>SINGLE: 960A235 USED ON: EasyMix Kitchen Faucets</p>	<p>HALSEY TAYLOR</p>  <p>SINGLE: 948H002 USED ON: Drinking fountains</p>  <p>FORMER STYLE</p>	<p>HARCRAFT</p>  <p>PAIR: HA33H DIV: HA33DH USED ON: 2 and 3 handled shower valves</p>											
<p>HAWS</p>  <p>SINGLE: 948W662 (OEM: 2710721.1) USED ON: Self closing drinking fountains</p>	<p>HAWS</p>  <p>PAIR: 948W660 (OEM: 2696938) USED ON: Pantry faucets</p>	<p>HAWS</p>  <p>EACH: 948W661 (OEM: 2698910) USED ON: Pantry faucets</p>											
<p>HAWS</p>  <p>STAINLESS: HH02 PLASTIC: HP01 USED ON: Drinking fountains with push button activators</p>	<p>HAWS</p>  <p>CHROME: 948W381 POL BRASS: 948W388 OEM: PBA-1 USED ON: Drinking fountains with recessed front sculpted bowls</p>	<p>HAWS</p>  <p>CHROME: 948W382 POL BRASS: 948W389 OEM: PBA-2 USED ON: Drinking fountains with recessed front stainless steel drinking fountains. (Includes hole plugs to use on fountain when replacing a push bar.)</p>											
<p>HAWS</p>  <p>CHROME: 948W383 OEM: PBA-3 USED ON: Round front stainless steel drinking fountains (Includes hole plugs to use on fountain when replacing a push bar.)</p>	<p>HAWS</p>  <p>CHROME: 948W384 OEM: PBA-4 USED ON: Drinking fountains with recessed front push buttons</p>	<p>HAWS</p>  <p>CHROME: 948W385 OEM: PBA-5 USED ON: Drinking fountains with wall thickness more than 5/8" thick (i.e. ceramic fountains)</p>											
<p>HAWS</p>  <p>CHROME: 948W386 POL BRASS: 948W390 OEM: PBA-6 USED ON: Stainless steel drinking fountains</p>	<p>HAWS</p>  <p>CHROME: 948W387 OEM: PBA-7 USED ON: Drinking fountains with front recessed push buttons and for drinking fountains with wall thickness more than 5/8" thick (i.e. ceramic fountains)</p>	<p>Use the following buttons with these regulators:</p>  <p>PBA-1 PBA-2 PBA-3 PBA-4 PBA-5</p> <p>Use the following buttons with this regulator:</p>  <p>PBA-6 PBA-7</p>											
<p>HAWS Front - and side- bars for push bar fountains. Also used by other manufacturers.</p> 	<p>Many Haws drinking fountain handles are only available in valve rebuild kits. These kits are shown in section 2.</p>		<p>HARDWARE: (sold EACH)</p> <table border="1"> <thead> <tr> <th>CAT #</th> <th>DESCRIPTION:</th> </tr> </thead> <tbody> <tr> <td>948W339</td> <td>screw for side bars</td> </tr> <tr> <td>948W340</td> <td>spacer for side bars</td> </tr> <tr> <td>948W341</td> <td>screw for front bar</td> </tr> <tr> <td>948W342</td> <td>spacer for front bar</td> </tr> </tbody> </table>	CAT #	DESCRIPTION:	948W339	screw for side bars	948W340	spacer for side bars	948W341	screw for front bar	948W342	spacer for front bar
CAT #	DESCRIPTION:												
948W339	screw for side bars												
948W340	spacer for side bars												
948W341	screw for front bar												
948W342	spacer for front bar												
<p>FRONT PANEL BARS: TAN: 948W330 (OEM: 160000) GRAY: 948W331 (OEM: 160003) CHROME: 948W332 (OEM: 160006)</p>	<p>LEFT PANEL BARS: TAN: 948W333 (OEM: 160002) GRAY: 948W334 (OEM: 160005) CHROME: 948W335 (OEM: 160008)</p>	<p>RIGHT PANEL BARS: TAN: 948W336 (OEM: 160001) GRAY: 948W337 (OEM: 160004) CHROME: 948W338 (OEM: 160007)</p>											

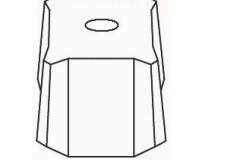
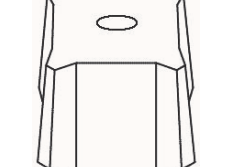
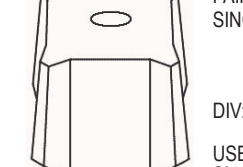
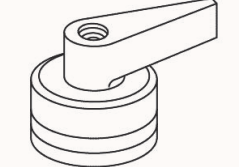
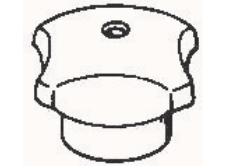
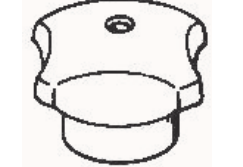

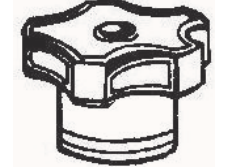
INDIVIDUAL PARTS / FAUCET REPAIRS







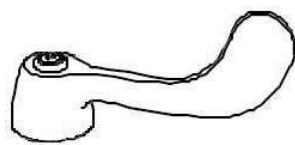

FAUCET HANDLES (cont.)

<p>KOHLER</p>  <p>PAIR: KO32AH (2" tall)</p> <p>SCREW: 226C003</p> <p>USED ON: Triton 2 handled bath and shower valves, some showers</p> <p>Base Diameter: 1-13/16" Center to Tip dimension: 2-1/2"</p>	<p>KOHLER</p>  <p>PAIR: KO13AH (OEM version - 1-1/2" tall)</p> <p>SCREW: 226C003</p> <p>USED ON: Triton Lav Faucets, others</p> <p>Base Diameter: 1-5/16" Center to Tip dimension: 1-7/8"</p>	<p>KOHLER</p>  <p>PAIR: KO13AHX (Economy handle pair with adapters - 1-1/2" tall)</p> <p>SCREW: 226C003</p> <p>USED ON: Triton Lav Faucets, others</p> <p>Base Diameter: 1-5/16" Center to Tip dimension: 1-7/8"</p>
<p>KOHLER</p>  <p>PAIR: KO06H</p> <p>HOT: KO3583 COLD: KO3582 BLANK: 9KO0989</p> <p>SCREW: 226C003</p> <p>USED ON: Ledge and concealed sink and lav faucets, some showers</p> <p>Center to Tip dimension: 1-7/8"</p>	<p>KOHLER</p>  <p>PAIR: KO15H</p> <p>USED ON: Shoreham sink and lav</p>  <p>Former style</p> <p>Center to Tip dimension: 1-3/4"</p>	<p>KOHLER</p>  <p>PAIR: KO36H</p> <p>USED ON: Shoreham shower and bath</p>  <p>Former style</p> <p>Center to Tip dimension: 2-1/2"</p>
<p>KOHLER</p>  <p>PAIR: KO12H</p> <p>USED ON: Lav faucets</p>	<p>KOHLER</p>  <p>PAIR: KO15PH (Clear plastic)</p> <p>USED ON: 2 handled bath and shower valves</p>	<p>KOHLER</p>  <p>PAIR: KO15AH (metal) SINGLE: 9KO0364 (metal)</p> <p>DIV: KO15AHD (metal)</p> <p>USED ON: Shower and bath</p>
<p>KOHLER</p>  <p>HOT: KO35021 COLD: KO35022</p> <p>USED ON: Constellation ledge sink</p>	<p>KOHLER</p>  <p>PAIR: KO31H</p> <p>USED ON: Triton II Lav faucets</p> <p>Base Diameter: 1-1/4"</p>	<p>KOHLER</p>  <p>PAIR: KO33H DIV: KO33HD</p> <p>USED ON: Triton II bath and shower valves</p>
<p>KOHLER</p>  <p>PAIR: 9KO3437</p> <p>USED ON: Triton II and Alterna Rite- temp mixing valves</p> <p>Tip to Tip dimension: 2-1/8"</p>	<p>KOHLER</p>  <p>PAIR: KO06AH SCREW: 226C003</p> <p>USED ON: Sink and lav faucets</p> <p>Tip to Tip dimension: 1-13/16"</p>	<p>KOHLER</p>  <p>PAIR: KO32H (Use with sliding sleeve)</p> <p>USED ON: 2 handled showers with sliding sleeve</p> <p>Tip to Tip dimension: 2-1/8"</p>
<p>KOHLER</p>  <p>OEM PAIR: KO30H GENERIC PAIR: KO30AH</p> <p>HOT: KO3597 COLD: KO3596</p> <p>DIV: 9KO0989</p> <p>SCREW: 226C003</p> <p>USED ON: 2 handled bath and shower valves</p> <p>Tip to Tip dimension: 2-5/8"</p>	<p>KOHLER</p>  <p>PAIR: 948K005</p> <p>HOT INDEX: 948K029 COLD INDEX: 948K030 BLANK INDEX: 948K031</p> <p>USED ON: Self closing lav and Drinking fountains</p> <p>Tip to Tip dimension: 2-5/8"</p>	<p>Notes:</p> 

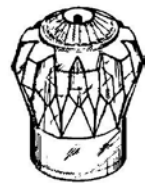
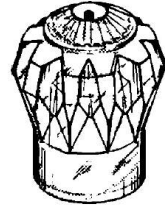
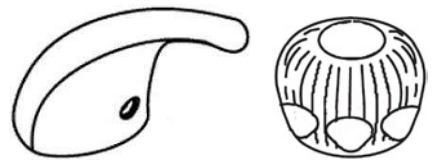
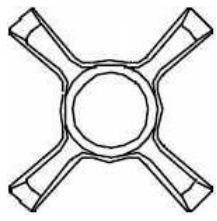
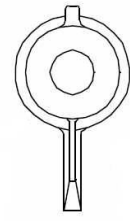
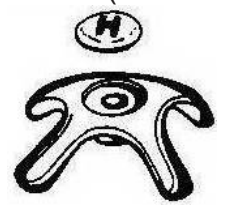
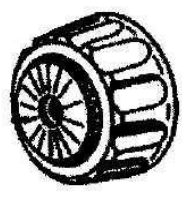
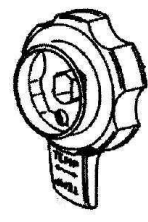

INDIVIDUAL PARTS / FAUCET REPAIRS





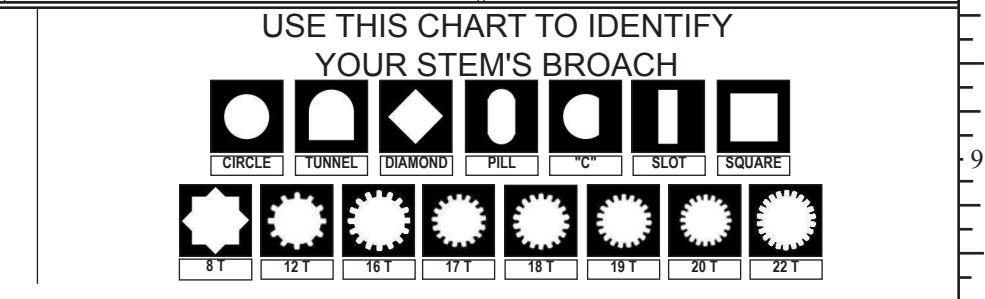
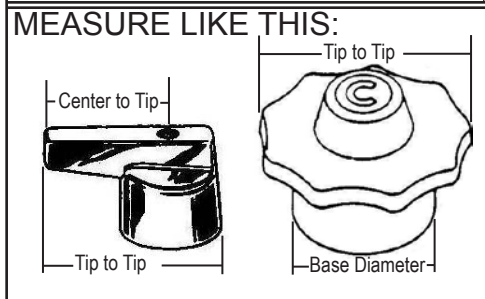





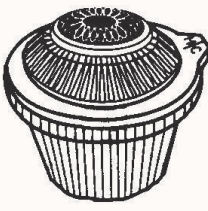

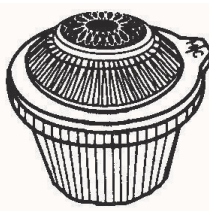

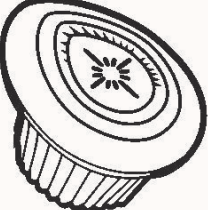

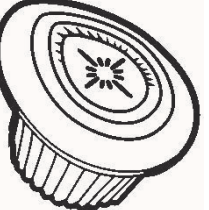

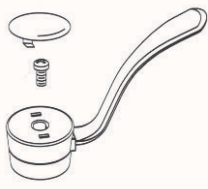
FAUCET HANDLES (cont.)

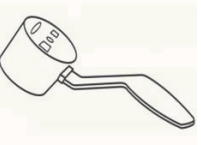
 <p>KOHLER WRIST BLADE HANDLES ARE SHOWN ON PAGE 1-38</p>	<p>KOHLER</p>  <p>SINGLE: 9K00503 (OEM# 22141)</p> <p>USED ON: Niedecken exposed mixing valve</p>	<p>KOHLER</p>  <p>SINGLE: 947K002 (OEM# 22920)</p> <p>SCREW: 947K001</p> <p>USED ON: Niedecken exposed mixing valve</p>
<p>KOHLER</p>  <p>PAIR: KO34HT (old style)</p> <p>SCREW: 226C003</p> <p>USED ON: Old style 2 handled lav, bath and shower valves</p>	<p>KOHLER</p>  <p>PAIR: 9K03127</p> <p>INDEX: 9K03099</p> <p>USED ON: Flair 2 handled lav and kitchen faucets</p>	<p>KOHLER</p>  <p>PAIR: KO34H (oem)</p> <p>PAIR: KO34HT (Economy Handle pair with adapters)</p> <p>USED ON: Flair 2 handled bath and shower valves</p>
 <p>KOHLER SINGLE LEVER HANDLES ARE SHOWN ON PAGE 1-40</p>	<p>LEONARD</p>  <p>SINGLE: 9LE0107 (OEM# 57K)</p> <p>INDEX: 9LE0106 (OEM# 57L-CP)</p> <p>USED ON: Mixing valves</p>	<p>LEONARD</p>  <p>SINGLE: 9LE0104 (OEM# MU5D)</p> <p>INDEX: 9LE0106 (OEM# 57L-CP)</p> <p>USED ON: Mixing valves</p>
<p>LOGAN (ACORN)</p>  <p>SINGLE: 938L003</p> <p>BLANK INDEX: 938L020 HOT INDEX: 938L001 COLD INDEX: 938L002</p> <p>SCREWS: 938L008 (Bag of 10 screws)</p> <p>USED ON: Penal shower valves</p>	<p>MIXET</p>  <p>SINGLE: 9MX0029 (OEM# MRH-CLR)</p> <p>USED ON: Clear volume handle for shower valves</p>	<p>MIXET</p>  <p>SINGLE: 9MX0031 (OEM# MTH-CLR)</p> <p>USED ON: Clear temperature handle for shower valves</p>
<p>MIXET</p>  <p>SINGLE: 9MX0060 (OEM# MLH-HH)</p> <p>USED ON: Metal loop temperature handle for shower valves</p>	<p>MIXET</p>  <p>SINGLE: 9MX0009 (OEM# MRH-MET)</p> <p>USED ON: Metal temperature handle for shower valves</p>	<p>MIXET</p>  <p>SINGLE: 9MX0030 (OEM# MLH-MET - metal)</p> <p>SINGLE: 9MX0011 (OEM# MLH-CP - plastic)</p> <p>USED ON: Temperature handle for shower valves</p>

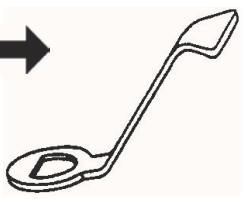
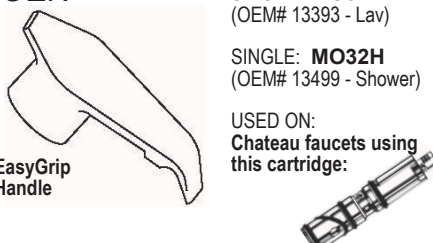

INDIVIDUAL PARTS / FAUCET REPAIRS

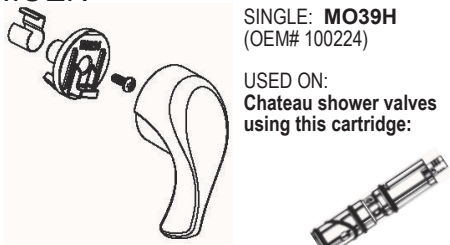

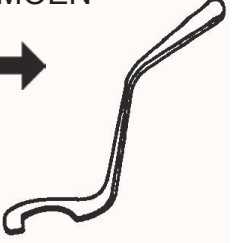
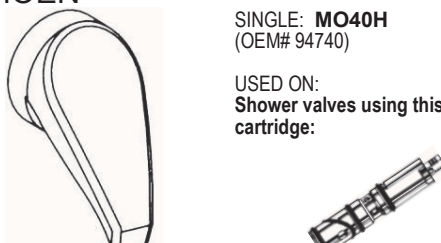



FAUCET HANDLES (cont.)

<p>MOEN</p> <p>SINGLE: MO06H</p> <p>USED ON: Round (old style) handle for Chateau shower faucets</p>   <p>SHOWER: LONG INSERT</p>	<p>MOEN</p> <p>SINGLE: MO07H</p> <p>USED ON: Round (old style) handle for Chateau lav faucets</p>   <p>LAV: SHORT INSERT</p>	<p>HANDLE PULLER FOR MOEN CARTRIDGES</p> <p>Solid brass construction - removes the complete cartridge.</p> <p>ALSO removes the core shell, should the core and shell become separated.</p>  <p>CAT NO: 5911120</p>
<p>MOEN</p> <p>SINGLE: MO08H (generic) 9MO0258 (OEM)</p> <p>USED ON: Egg handle for Chateau shower faucets</p>   <p>SHOWER: LONG INSERT</p>	<p>MOEN</p> <p>SINGLE: MO09H (generic) 9MO0259 (OEM)</p> <p>USED ON: Egg handle for Chateau lav faucets</p>   <p>LAV: SHORT INSERT</p>	 <p>All handles on this page are used with either Moen's plastic cartridge #1225 (Cat # 946P095), or brass cartridge #1200 (Cat # 946M095).</p>
<p>MOEN</p> <p>SINGLE: 9MO0088 (OEM# 2021)</p> <p>USED ON: 7300, and other kitchen faucets. (Includes index and screw)</p>  <p>FORMER STYLE: </p> <p>Center to Tip dimension: 4-1/2"</p>	<p>MOEN</p> <p>SINGLE: 9MO0079 (OEM# 1723)</p> <p>INDEX: 121C031</p> <p>SCREW: 226C002</p> <p>USED ON: Model 4400, 8450 and other single lever lav faucets</p>  <p>Center to Tip dimension: 2-3/4"</p>	<p>MOEN retainer clips</p>  <p>946M006 OEM: 883 (Chateau)</p> <p>946M007 OEM: 1883 (Chateau)</p> <p>946M009 OEM: 96914 (PosiTemp)</p>
<p>MOEN</p> <p>SINGLE: MO10H</p> <p>3 piece cap set (OEM# 96790)</p> <p>USED ON: Chateau single lever kitchen faucets</p> <p>USE WITH: 946M019</p> <p>FORMER STYLE: </p> 	<p>MOEN</p> <p>SINGLE: 946M019 (OEM# 10927)</p> <p>USED ON: Chateau single lever kitchen faucets</p> <p>USE WITH: MO10H</p>  <p>Center to Tip dimension: 4-3/4"</p>	<p>MOEN</p> <p>SINGLE: MO02H (OEM# 13393 - Lav)</p> <p>SINGLE: MO32H (OEM# 13499 - Shower)</p> <p>USED ON: Chateau faucets using this cartridge:</p>  <p>EasyGrip Handle</p>
<p>MOEN</p> <p>SINGLE: 9MO0610 (OEM# 92514)</p> <p>USED ON: Chateau single lever kitchen faucets</p> <p>USE WITH: 9MO0611</p> 	<p>MOEN</p> <p>SINGLE: 9MO0611 (OEM# 92361 / 10112)</p> <p>USED ON: Chateau single lever kitchen faucets</p> <p>USE WITH: 9MO0610</p> 	<p>MOEN</p> <p>SINGLE: MO39H (OEM# 100224)</p> <p>USED ON: Chateau shower valves using this cartridge:</p> 
<p>MOEN</p> <p>SINGLE: 9MO0614 (OEM# 14491)</p> <p>USED ON: Chateau single lever kitchen faucets</p> <p>USE WITH: 9MO0613</p> <p>Note: Top cap available separately: SP55854</p> 	<p>MOEN</p> <p>SINGLE: 9MO0613 (OEM# 14492)</p> <p>USED ON: Chateau single lever kitchen faucets</p> <p>USE WITH: 9MO0614</p> 	<p>MOEN</p> <p>SINGLE: MO40H (OEM# 94740)</p> <p>USED ON: Shower valves using this cartridge:</p> 

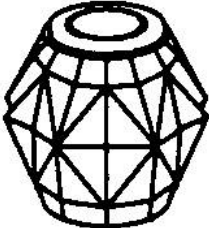

INDIVIDUAL PARTS / FAUCET REPAIRS

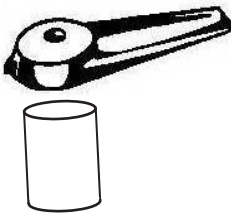
FAUCET HANDLES (cont.)

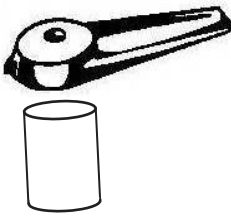
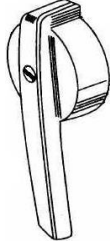
<p>MOEN</p>  <p>SINGLE: MO33H (OEM# 96884)</p> <p>USED ON: PosiTemp</p> 	<p>MOEN</p>  <p>SINGLE: MO38H (OEM# 14732)</p> <p>USED ON: PosiTemp</p> 	<p>MOEN</p>  <p>SINGLE: MO37H (OEM# 13291)</p> <p>USED ON: PosiTemp</p> 
<p>MOEN</p>  <p>SINGLE: MO34H (OEM# 100657)</p> <p>USED ON: PosiTemp</p> 	<p>MOEN</p>  <p>PAIR: MO05H (OEM# 100695)</p> <p>USED ON: Moentrol 2 handle lav and kitchen faucets</p> <p>USE WITH:</p> 	<p>MOEN</p>  <p>HOT: MO6611 COLD: MO6610</p> <p>USED ON: Moentrol 2 handle lav and kitchen faucets</p> <p>USE WITH: MO6606 Hot cartridge MO6607 Cold Cartridge MO6609 Torx Wrench</p>
<p>MOEN</p>  <p>SINGLE: 946M098 (OEM# 530)</p> <p>USED ON: Pre-cartridge faucets</p>	<p>MOEN Self Closing Faucet</p>  <p>This series has been discontinued by MOEN. Limited parts (including the cartridge,) are still available. The handle is no longer available.</p> <p>Cartridge: MO44TG (OEM: 16352)</p>	<p>SELF CLOSING ADA PUSH CONVERSION KIT FOR MOEN FAUCETS</p> <p>Turns a Moen "pull and turn" faucet into a ADA approved PUSH faucet. Self closes as soon as the handle is released.</p>  <p>Kit includes: New self closing cartridge and clips, new "PUSH" handle, low flow aerator, and necessary adapters.</p> <p>CAT NO: MO1200C</p>
<p>POWERS</p>  <p>SINGLE: 9PR0173 (OEM: 420-481)</p> <p>INDEX: 121C091</p> <p>USED ON: Series 420R mixing valves (Models 3,4,5,6)</p>	<p>POWERS</p>  <p>SINGLE: 9PR0400 (OEM: 400-078)</p> <p>INDEX: 121C091</p> <p>USED ON: Various mixing valves</p>	<p>POWERS</p>  <p>SINGLE: 9PR0502 (WITH sleeve) (OEM: 420-243)</p> <p>SCREW: 227C028</p> <p>USED ON: Hydroguard mixing valves</p>
<p>POWERS</p>  <p>SINGLE: 9PR0436 (OEM: 420-336)</p> <p>SCREW: 227C028</p> <p>USED ON: Biltmore 800 series mixing valves</p>	<p>POWERS</p>  <p>SINGLE: 9PR0200 (LESS sleeve) (OEM: 420-495)</p> <p>SCREW: 227C028</p> <p>USED ON: Hydroguard mixing valves</p>	<p>POWERS</p>  <p>SINGLE: 9PR0502 (WITH sleeve) (OEM: 420-243)</p> <p>SCREW: 227C028</p> <p>USED ON: Hydroguard mixing valves</p>
<p>POWERS</p>  <p>SINGLE: 9PR0134 (OEM: 420-242)</p> <p>SCREW: 227C028</p> <p>USED ON: Hydroguard 427, 428, and other mixing valves</p>	<p>POWERS</p>  <p>SINGLE: 9PR0836 (OEM: 800-036)</p> <p>SCREW: 227C028</p> <p>USED ON: Biltmore 900 series mixing valves</p>	<p>POWERS</p>  <p>SINGLE: 9PR0936 (OEM: 900-036)</p> <p>SCREW: 227C028</p> <p>USED ON: Biltmore 900 series mixing valves</p>



INDIVIDUAL PARTS / FAUCET REPAIRS

FAUCET HANDLES (cont.)

1
2
3
4
5
6
7
8
9

PRICE PFISTER



PAIR: **PF05H**
SCREW: **227C007**
USED ON:
Crown Jewel
kitchen faucets

Center to Tip dimension: **1-3/4"**

PRICE PFISTER

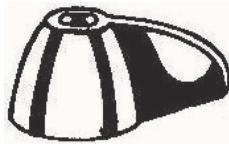

PAIR: **PF15H**
SCREW: **227C007**
USED ON:
Crown Jewel
lavy and wallmount
faucets

Center to Tip dimension: **1-1/2"**

PRICE PFISTER



PAIR: **PF10H**
HOT: **PF4683**
COLD: **PF4684**
SCREW: **227C007**
USED ON:
Crown Imperial

Center to Tip dimension: **1-1/4"**

PRICE PFISTER



PAIR: **PF16H**
DIV: **9PF0277**
SCREW: **227C007**
USED ON:
Contempera lav and
mobile home showers

Tip to Tip dimension: **1-15/16"**

PRICE PFISTER



PAIR: **PF16AH**
DIV: **9PF0463**
SCREW: **227C007**
USED ON:
Verve lav and mobile
home showers

Height: **1-1/2"**
Center to Tip dimension: **7/8"**

PRICE PFISTER



PAIR: **PF17H**
H INDEX: **9PF0992**
C INDEX: **9PF0991**
SCREW: **227C002**
USED ON:
Windsor (small)

Height: **1-7/8"**
Center to Tip dimension: **15/16"**

PRICE PFISTER



PAIR: **9PF0395**
SCREW: **227C002**
USED ON:
Marquis sink and lav

Tip to Tip dimension: **2"**

PRICE PFISTER



PAIR: **9PF0411**
USED ON:
Contessa faucets

Tip to Tip dimension: **2-1/2"**

PRICE PFISTER



COLD: **9PF0411**
HOT: **9PF0415**
DIV: **9PF0419**

SCREW: **227C028**
USED ON:
Contessa bath & shower

PRICE PFISTER



SINGLE: **PF30H**
SCREW: **227C002**
USED ON:
BeauxArt
bath and shower

Tip to Tip dimension: **2-3/4"**

PRICE PFISTER



SINGLE: **9PF0332**
USED ON:
Beaux Art
bath & showers

PRICE PFISTER

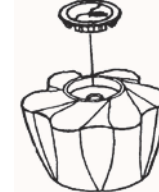

PAIR: **PF18H**
USED ON:
Lavy faucets
(oem 940-404)

(Plastic)

Tip to Tip dimension: **2-3/4"**

PRICE PFISTER

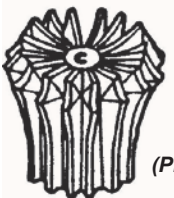

PAIR: **PF32H**
DIV: **PF32HD**
USED ON:
Marquis bath & shower

(Plastic)

Tip to Tip dimension: **3"**

PRICE PFISTER



PAIR: **PF33H**
DIV: **PF33HD**
USED ON:
Contempera
bath & shower

(Metal)

Height: **2-1/4"**
Base Diameter: **2-1/2"**

PRICE PFISTER



PAIR: **PF37H**
DIV: **PF37HD**
USED ON:
Bath & shower
(oem 940-444)

(Plastic)

Tip to Tip dimension: **2-3/4"**

PRICE PFISTER



PAIR: **PF35H**
DIV: **PF35HD**
USED ON:
Windsor bath & shower

(Plastic)

Base Diameter: **2-1/2"**

PRICE PFISTER



PAIR: **PF36H**
DIV: **PF36HD**
USED ON:
Bath & shower

(Metal)

Base Diameter: **2-1/2"**

PRICE PFISTER



PAIR: **PF34H**
DIV: **PF34HD**
USED ON:
Verve bath & shower

(Metal)

Base Diameter: **2-3/4"**



INDIVIDUAL PARTS / FAUCET REPAIRS

FAUCET HANDLES (cont.)

PRICE PFISTER



SINGLE: **9PF0343**
USED ON:
Flow-Matic serv-all
sink & lav

PRICE PFISTER



SINGLE: **9PF0338**
USED ON:
Flow-Matic lav,
tub, and shower

PRICE PFISTER

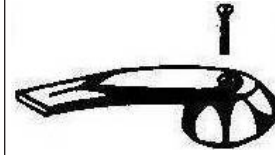

SINGLE: **9PF0344**
USED ON:
Flow-Matic
sink faucets

MORE PRICE PFISTER KITCHEN HANDLES
SHOWN ON PAGE 2-172

PRICE PFISTER

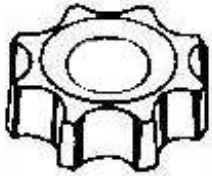

PAIR: **PF31H**
HOT: **PF4707**
COLD: **PF4706**
USED ON:
Crown Imperial Shower
(Use with PF31HD)

PRICE PFISTER

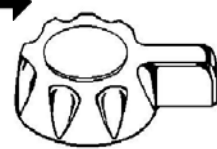

DIVERTER: **PF31HD**
USED ON:
Crown Imperial Shower
(Use with PF31H)

PRICE PFISTER

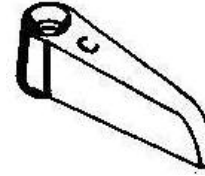

COLD: **9PF0325**
HOT: **9PF0327**
USED ON:
Crown Imperial Shower
(Use with PF31HD)

DIVERTER

PRICE PFISTER (SINGLE - OLD STYLE)

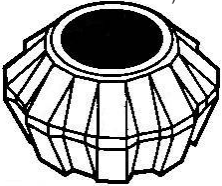

SINGLE: **PF44H**
(NON OEM)
USED ON:
Shower valves

PRICE PFISTER (SINGLE - NEW STYLE)

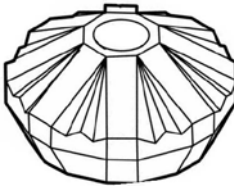

SINGLE: **9PF0976**
(OEM: 940-950A
-less index button.)
(formerly 940-240))
SINGLE: **PF46H**
(NON-OEM - includes
index button.)

PRICE PFISTER (MULTI HANDLE)

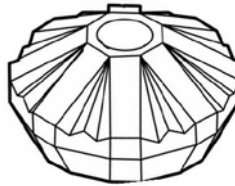

SINGLE: **9PF1976**
(OEM: 940-801)
PAIR: **PF45H**
(NON-OEM -
includes index buttons.)
DIVERTER: **PF45HD**
(NON-OEM -
includes index button.)

INDEXES SHOWN
ON PAGE 1-64

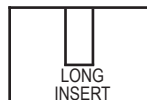

INDEXES SHOWN
ON PAGE 1-64

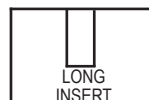

INDEXES SHOWN
ON PAGE 1-64

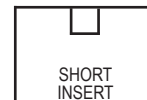

PRICE PFISTER

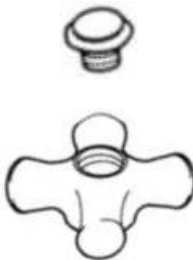

CROSS DECO SERIES:
BUTTONS:
C, white/chrome: **9PF3111**
C, white/pol brass: **9PF3112**
H, white/chrome: **9PF3113**
H, white/pol brass: **9PF3114**
Arrow, white/CP: **9PF3115**
Arrow, white/PB: **9PF3116**

CROSS
Chrome: **9PF3104**
Polished Brass: **9PF3105**
Porcelain: **9PF3106**



HUB
Chrome: **9PF3102**
Polished Brass: **9PF3103**

PRICE PFISTER



GRIP DECO SERIES:

GRIP
Chrome/white: **9PF3107**
Pol.brass/white: **9PF3108**
Chrome: **9PF3109**
Polished Brass: **9PF3110**



HUB
Chrome: **9PF3100**
Polished Brass: **9PF3101**

PRICE PFISTER

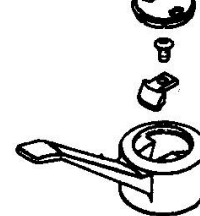

INDEX: **9PF1013**
SCREW: **9PF0831**
YOKE: **9PF1014**
HANDLE: **9PF1015**

USED ON:
Avante kitchen faucets

PRICE PFISTER

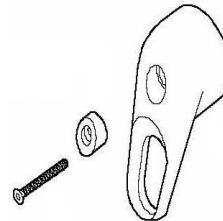

Please see page 1-40
for Price Pfister's
lever handle
variations for the
Avante shower valves

PRICE PFISTER



DECO FLANGE
Chrome: **9PF3117**
Polished Brass: **9PF3118**

PRICE PFISTER



FLAT FLANGE
Chrome: **9PF3119**
Polished Brass: **9PF3120**

PRICE PFISTER

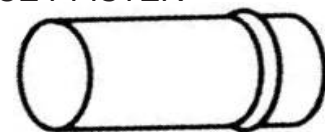





SLEEVE
Chrome: **9PF3121**
Polished Brass: **9PF3122**

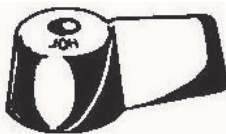

INDIVIDUAL PARTS / FAUCET REPAIRS

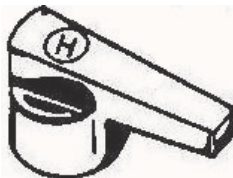











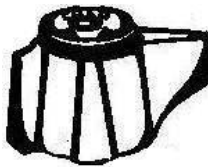

FAUCET HANDLES (cont.)

<p>REPCAL</p>  <p>PAIR: RC02HX (Economy handle pair with adapters)</p> <p>USED ON: Ledge sinks</p> <p>Center to Tip: 1-7/8"</p>	<p>REPCAL</p>  <p>PAIR: RC30H</p> <p>HOT: RC4885 COLD: RC4884</p> <p>USED ON: Bath & shower</p> <p>Tip to tip: 2-1/2"</p>	 <p>ALL HANDLES PACKED WITH SCREWS & INDEXES (WHERE APPLICABLE)</p>
<p>RICHMOND</p>  <p>PAIR: R111HX</p> <p>USED ON: Type "S" lavs, also fits Savoy back mount faucets</p> <p>Tip to Tip dimension: 2-3/4"</p>	<p>SAVOY</p>  <p>PAIR: SV02H</p> <p>SCREW: 227C017</p> <p>USED ON: Sink and lav faucets</p> <p>Center to Tip: 1-7/8"</p>	<p>SAVOY</p>  <p>HOT: SV6013 COLD: SV6014 (Solid brass)</p> <p>SCREW: 227C017</p> <p>USED ON: Sink and lav faucets</p> <p>Tip to tip: 2-1/2"</p>
<p>SAVOY</p>  <p>PAIR: SV01H</p> <p>DIV: SV6019</p> <p>SCREW: 227C017</p> <p>USED ON: Sink and lav faucets</p> <p>Center to Tip: 1-7/8"</p>	<p>SAVOY</p>  <p>HOT: SV5991 COLD: SV5992 (Solid brass)</p> <p>SCREW: 227C017</p> <p>USED ON: Sink and lav faucets</p> <p>Center to Tip: 1-7/8"</p>	<p>SAVOY</p>  <p>LOOP: SV6011 INDEX: 121C041</p> <p>SOLID: SV6012 (Solid brass)</p> <p>USED ON: Sink and lav faucets</p>
<p>SAYCO</p>  <p>PAIR: SC11H</p> <p>H Index: 121C035 C Index: 121C034</p> <p>SCREW: 227C003</p> <p>USED ON: Sink and lav faucets</p> <p>Center to tip: 1-3/8"</p>	<p>SAYCO</p>  <p>PAIR: SC33H</p> <p>H Index: 121C035 C Index: 121C034</p> <p>SCREW: 227C003</p> <p>USED ON: Bath and shower</p> <p>Base Diameter: 1-5/16"</p>	<p>SAYCO</p>  <p>PAIR: SC36H</p> <p>COLD: SC6970 HOT: SC6971</p> <p>USED ON: Sink and lav faucets</p> <p>Tip to tip: 2-1/2"</p>
<p>SAVCO</p>  <p>EACH: 9SC0215</p> <p>H Index: 121C035 C Index: 121C034</p> <p>SCREW: 227C003</p> <p>USED ON: Sink and lav faucets</p>	<p>SAYCO</p>  <p>PAIR: SC34H</p> <p>USED ON: Lav, bath, and shower valves</p> <p>Base Diameter: 1-5/16"</p>	<p>SCHAIBLE</p>  <p>EACH: SY02H</p> <p>HOT: AK287 COLD: AK286</p> <p>USED ON: Deck sink and concealed sink faucets</p> <p>Center to tip: 2-1/8"</p>
<p>SPEAKMAN</p>  <p>PAIR: SP03H</p> <p>Height: 1-1/2" Center to Tip dimension: 7/8"</p> <p>USED ON: Lavy faucets</p>	<p>SPEAKMAN</p>  <p>PAIR: SP04H</p> <p>HOT: SP5793 COLD: SP5792</p> <p>USED ON: Backmount sinks</p>	<p>SPEAKMAN</p>  <p>FORMER DESIGN</p> <p>PAIR: SP07H</p> <p>USED ON: Kent sink, and center set lav faucets</p> <p>Center to tip: 1-5/16"</p>

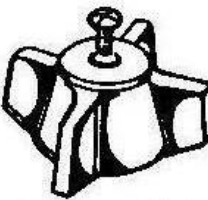

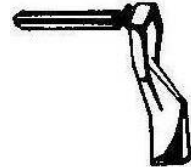
INDIVIDUAL PARTS / FAUCET REPAIRS

FAUCET HANDLES (cont.)

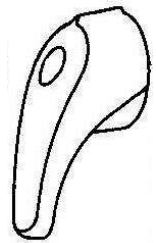
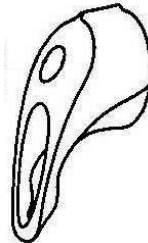
<p>SPEAKMAN</p>  <p>SINGLE: 947P003 SCREW: 947P011</p> <p>USED ON: Commander and Diamond concealed mixometers</p>	<p>SPEAKMAN</p>  <p>HOT: 949P007 COLD: 949P008</p> <p>USED ON: Easy-Push metering lavys</p>  <p>PAIR: SP03H</p> <p>Height: 1-1/2" Center to Tip dimension: 7/8"</p>	<p>SPEAKMAN</p>  <p>PAIR: SP08H</p> <p>USED ON: Commander II mop sinks (for ceramic stems)</p> <p><i>(Includes adapters for skinny broached stems, and CP sleeves to hide brass stems.)</i></p>  <p>PAIR: SP30H</p> <p>USED ON: Commander II mop sinks (for compression stems)</p>
<p>STERLING FAUCET</p>  <p>PAIR: SF01H</p> <p>USED ON: Ledge and backmount sinks and lavs</p>	<p>STERLING FAUCET</p>  <p>PAIR: SF06H (OEM handle pair)</p> <p>SCREW: 227C008</p> <p>USED ON: Accent trim lav faucets and showers</p>	<p>STERLING FAUCET</p>  <p>PAIR: SF06HX (Economy handle pair with adapters)</p> <p>SCREW: 227C008</p> <p>USED ON: Accent trim lav faucets and showers</p>
<p>STERLING FAUCET</p>  <p>PAIR: SF02H</p> <p>USED ON: All Tempoline series valves</p>	<p>STERLING FAUCET</p>  <p>PAIR: SF10H</p> <p>HOT: SF5383 COLD: SF5382</p> <p>USED ON: 22-810 series & S600 bath and shower</p>	<p>STERLING FAUCET</p>  <p>PAIR: SF30H</p> <p>USED ON: Accent trim lav faucets and showers</p>
<p>STREAMWAY</p>  <p>PAIR: SW01H</p> <p>USED ON: Lav & sink faucets</p>	<p>STREAMWAY</p>  <p>PAIR: SW10H</p> <p>USED ON: Lav & sink faucets</p>	<p>SYMMONS</p>  <p>SINGLE: 947S232 (OEM: T30)</p> <p>USED ON: Temptrol diverter volume handle</p>
<p>SYMMONS</p>  <p>SINGLE: 947S212 (OEM: T31)</p> <p>SCREW: 947S211</p> <p>USED ON: Temptrol tub & shower (use with TA-10 cartridge)</p>	<p>SYMMONS</p>  <p>SINGLE: 947S001 (OEM: RC14)</p> <p>USED ON: Safetymix tub & shower (use with C-5 cartridge)</p>	<p>SYMMONS</p>  <p>SINGLE: 947S320 (OEM: RC14X)</p> <p>USED ON: Temptrol tub & shower (use with TA-10 cartridge)</p>
<p>SYMMONS</p>  <p>SINGLE: 947S048 (OEM: T 101)</p> <p>USED ON: Temptrol tub & shower (use with TA-10 cartridge)</p>	<p>SYMMONS</p>  <p>SINGLE: 947S667 (OEM: T3 31S)</p> <p>USED ON: Temptrol tub & shower (use with TA-10 cartridge)</p>	<p>SYMMONS</p>  <p>SINGLE: 947S668 (OEM: T3 31L)</p> <p>USED ON: Temptrol tub & shower (use with TA-10 cartridge)</p>



INDIVIDUAL PARTS / FAUCET REPAIRS

FAUCET HANDLES (cont.)

1
2
3
4
5
6
7
8
9

SYMMONS



SINGLE: **947S669**
(OEM: KN 3BRB)

USED ON:
S-20 faucets
(use with 947S604
cartridge)
(OEM: KN-4)



SYMMONS



SINGLE: **947S671**
(OEM: LN 135)

USED ON:
S-20 faucets
(use with 947S604
cartridge)
(OEM: KN-4)



SYMMONS



SINGLE: **947S670**
(OEM: KN 3RB)

USED ON:
S-20 faucets
(use with 947S604
cartridge)
(OEM: KN-4)



SYMMONS

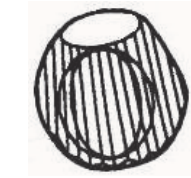

SINGLE: **947S661**
(OEM: LN 122)

USED ON:
S-20 faucets
(use with 947S604
cartridge)
(OEM: KN-4)



SYMMONS



SINGLE: **947S662**
(OEM: LL 18)

USED ON:
S-60 Scot faucets
'84-2000
(use with 947S660
cartridge)
(OEM: LL-1A)



SYMMONS

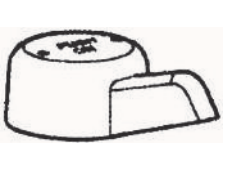

SINGLE: **947S663**
(OEM: LL 104)

USED ON:
S-60 Scot faucets
2000+
(use with 947S660
cartridge)
(OEM: LL-1A)



SYMMONS



SINGLE: **947S664**
(OEM: LT 37)

USED ON:
S-61 faucets '94-2000
(use with LT-1A
cartridge)



SYMMONS



SINGLE: **947S665**
(OEM: LT 100)

USED ON:
S-61 faucets 2001+
(use with 947S660
cartridge)
(OEM: LL-1A)



SYMMONS

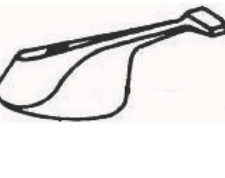

SINGLE: **947S666**
(OEM: L 2)

USED ON:
Temptrol faucets '74-'99
(use with 9SM0504
cartridge)
(OEM: L-4A)



SYMMONS



SINGLE: **947S091**
(OEM: J 3)

USED ON:
Safetymix"ette"
shower valve '64-'69
(use with 947S092
cartridge)
(OEM: J-4)

Center to tip: **1-5/8"**

T & S BRASS

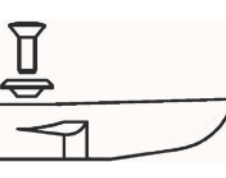

OEM PAIR: **TS05H**
GENERIC PAIR: **CL05H**

HOT: **TS23F**
COLD: **TS24F**

H Index: **TS173F**
C Index: **TS172F**
SCREW: **227C008**

USED ON:
**Pre-rinse units and
kitchen faucets**

T & S BRASS

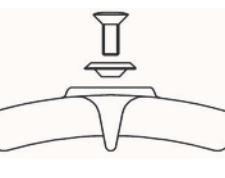

SINGLE: **TS175F**
4 ARM FAUCET HANDLE
(LESS INDEX, LESS
SCREW)
(OEM: 2521-45)

H Index: **TS173F**
C Index: **TS172F**
SCREW: **227C008**

USED ON:
Lab faucets

T & S BRASS

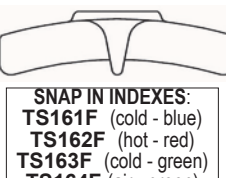

SINGLE: **TS5L**
4 ARM LAB HANDLE
(LESS INDEX, LESS
SCREW) (OEM: 59-40)

USED ON:
Lab faucets

SNAP IN INDEXES:
TS161F (cold - blue)
TS162F (hot - red)
TS163F (cold - green)
TS164F (air - green)
TS165F (vac - yellow)
TS166F (gas - blue)

T & S BRASS

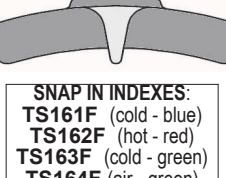

SINGLE: **TS193L**
BLACK VIKING HANDLE
(LESS INDEX, LESS
SCREW) (OEM: 193L)

USED ON:
Lab faucets

SNAP IN INDEXES:
TS161F (cold - blue)
TS162F (hot - red)
TS163F (cold - green)
TS164F (air - green)
TS165F (vac - yellow)
TS166F (gas - blue)

T & S BRASS

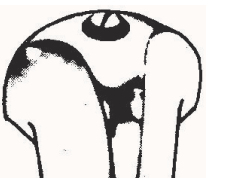

COLD: **TS180F**
HOT: **TS181F**
LAVATORY HANDLE
(WITH INDEX)
(OEM: 180F, 181F)

H Index: **TS173F**
C Index: **TS172F**
SCREW: **227C008**

USED ON:
Lab faucets

T & S BRASS

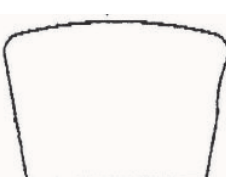

PLAIN: **TS14193**
HOT: **TS14194**
COLD: **TS14195**

USED ON:
Push style faucets

T & S BRASS

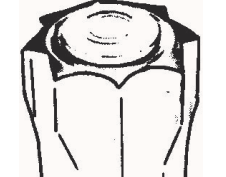

SINGLE: **TS76F**
CLEAR ALPINE HANDLE
(LESS INDEX)
(OEM:)

H Index: **TS171F**
C Index: **TS170F**
Blank: **TS169F**

USED ON:
Lab faucets

UNION BRASS

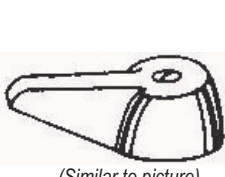

PAIR: **UB06HX**
(Economy handle pair
with adapters)

USED ON:
**Various ledge sink and
backmount sink and lav
faucets**

(Similar to picture)



INDIVIDUAL PARTS / FAUCET REPAIRS

FAUCET HANDLES (cont.)

VALLEY

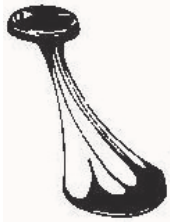

SINGLE: **VL06H**
USED ON:
Single lever
sink and lav faucets

VALLEY



SINGLE: **VL03H**
USED ON:
Single lever
lav faucets

VALLEY



SINGLE: **VL04H**
USED ON:
Single lever
kitchen faucets

VALLEY



SINGLE: **VL05H**
USED ON:
Single lever
sink and lav faucets

VALLEY



Height: 1-3/4"

PAIR: **VL01H**
(Includes inserts)
INSERT ONLY:
9VL0088

USED ON:
2 handled
sink and lav faucets

VALLEY



Height: 3"

PAIR: **VL07H**
(Includes inserts)
INSERT ONLY:
9VL0088

USED ON:
2 handled
tub and shower

VALLEY

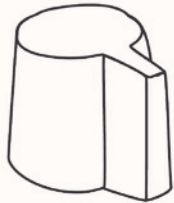

PAIR: **VL02H**
USED ON:
2 handled
sink and lav faucets

WATERSAVER

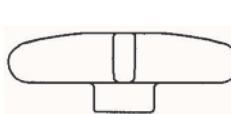

EACH: **WS01H**
(less index)
(OEM: BA 013 TS)
USED ON:
All Watersaver faucets

WATERSAVER

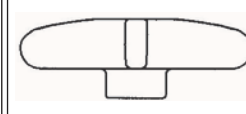

EACH: **WS02H**
(OEM: BA 013 TS)
USED ON:
All Watersaver faucets

WATERSAVER

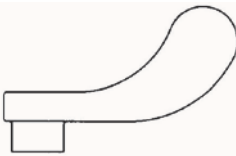

EACH: **WS03H**
(less index)
(OEM: BA 037 TS)
USED ON:
All Watersaver faucets

Center to Tip: 2-1/2"

WATERSAVER

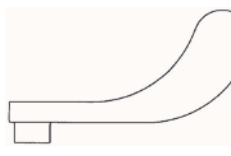

EACH: **WS06H**
(less index)
(OEM: BA 039 TS)
USED ON:
Self closing
Watersaver faucets

Center to Tip: 4"

WATERSAVER

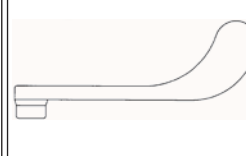

EACH: **WS07H**
(less index)
(OEM: BA 037 TS)
USED ON:
Various ledge sink and
bar mount sink and lav
faucets

Center to Tip: 6"

Notes:



WATERSAVER

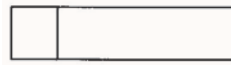

EACH: **WS04H**
(less index)
(OEM: BA 013 TS)
USED ON:
All Watersaver faucets

USE WS03H (ABOVE)

WATERSAVER

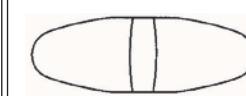

EACH: **WS12H**
(less index)
(OEM: PA 021 TS)
Nylon handle
USED ON:
All Watersaver faucets

WATERSAVER

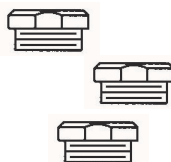

INDEX BUTTONS:
121C042 (cold - green)
121C043 (hot - red)
121C044 (vac - yellow)
121C047 (air - orange)
121C041 (DW - white)

YOUNGSTOWN



PAIR: **YT04H**
EACH: **YT6840**
USED ON:
Ledge sink faucets



INDIVIDUAL PARTS / FAUCET REPAIRS

FIT ALL PORCELAIN CROSS HANDLES

CAT NO.	FITS:		
261M030	"C" porcelain/chrome button		
261M031	"H" porcelain/chrome button		
261M032	Arrow porcelain/chrome button		
9 PF 3112	"C" porcelain/brass button		
9 PF 3114	"H" porcelain/brass button		
9 PF 3116	Arrow porcelain/brass button		
261M000	Porcelain cross handle (fits any broach adapter listed below)		
261M001	American Standard (7/16")		22pt
261M002	Briggs		18pt
261M003	Central Brass/Harden		16pt
261M004	Crane/Universal Rundle		12pt
261M005	Kohler		19pt
261M006	Gerber/Sayco		16pt
261M007	Savoy		15pt
261M008	Speakman		20pt
261M009	Sterling		16pt
261M010	Wolverine		15pt
261M011	European		20pt
261M012	Crane (Dial-Eze)		12pt
261M020	American Standard (7/16")		22pt
261M021	Briggs		18pt
261M022	Central Brass/Harden		16pt
261M023	Kohler		19pt
261M024	Price Pfister		12pt
261M025	Speakman		20pt
261M026	Savoy		15pt
261M027	Square		square

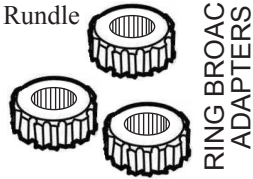

RING BROACH ADAPTERS



TALL BROACH ADAPTERS

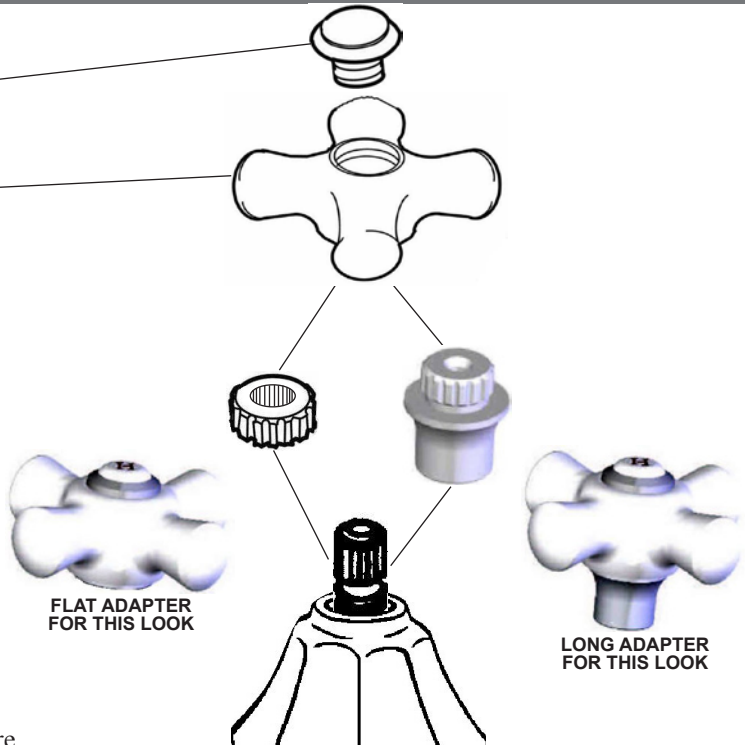

FLAT ADAPTER FOR THIS LOOK

LONG ADAPTER FOR THIS LOOK

INDEXES FOR FAUCET HANDLES

ACORN / LOGAN



DIAMETER: 7/8"

BLANK: 938L020
HOT: 938L001
COLD: 938L002

AMERICAN STANDARD



DIAMETER: 5/8"

HOT: 939C004
COLD: 939C003
BLANK: 9AS0827



DIAMETER: 21/32"
(CHROME)

HOT: 121C075
COLD: 121C076
ARROW: 121C051



DIAMETER: 21/32"
(COLORED)

PAIR: 9AS1038



DIAMETER: 13/16"

ARROW: 121C053
HOT: 939C001
COLD: 939C002

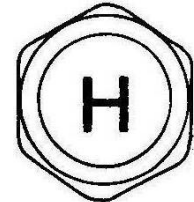

DIAMETER: 15/16"

HOT: 949A001
COLD: 949A002

AMERICAN STANDARD



DIAMETER: 1-5/16"

ARROW: 121C056
HOT: 121C055
COLD: 121C054

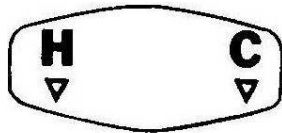

DIAMETER: 1-7/16"

SINGLE: 121C057

ARROWHEAD

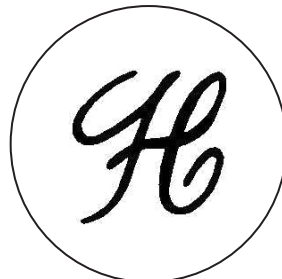

DIAMETER: 1-5/16"

ARROW: 121C091
HOT: 121C089
COLD: 121C090

BRIGGS



DIAMETER: 19/32"

RING ONLY: 121C003

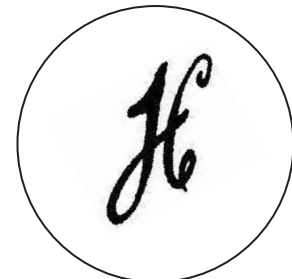

DIAMETER: 1-7/16"

HOT: 121C005
COLD: 121C004



INDIVIDUAL PARTS / FAUCET REPAIRS

INDEXES FOR FAUCET HANDLES (cont.)

CHICAGO

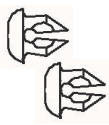

DIAMETER: 1/4"

9CF3360
(CONTAINS RED & BLUE BUTTONS)

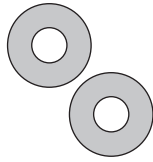

DIAMETER: 1/2"

HOT: **9CF0578**
COLD: **9CF0580**



DIAMETER: 3/4"

HOT: **121C007**
COLD: **121C008**

CRANE



DIAMETER: 1/2"

HOT: **121C059**
COLD: **121C058**



DIAMETER: 1/2"

HOT: **121C061**
COLD: **121C060**

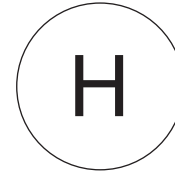

DIAMETER: 7/8"

HOT: **121C093**
COLD: **121C094**

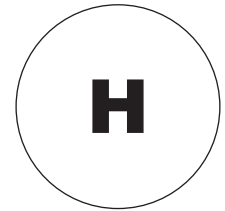

DIAMETER: 1-1/16"

HOT: **121C063**
COLD: **121C062**

CRANE

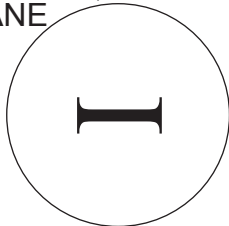

DIAMETER: 1-5/32"

HOT: **121C065**
COLD: **121C064**

CRESTLINE

(also used on Delta)



DIAMETER: 1"

HOT: **121C115**
COLD: **121C116**

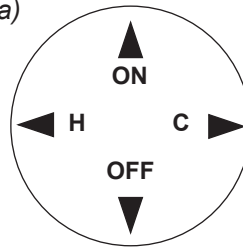

DIAMETER: 1-1/4"

SINGLE: **121C117**

DELTA / DELEX



DIAMETER: 1/2"

PAIR: **121C012**

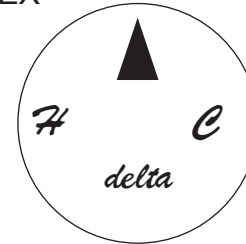

DIAMETER: 1-1/4"

SINGLE: **121C011**

ELJER

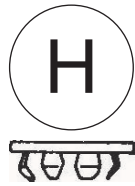

DIAMETER: 21/32"

PAIR: **121C075**

FISHER

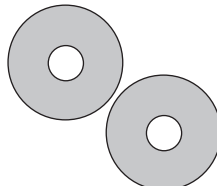

DIAMETER: 3/4"

HOT: **121C017**
COLD: **121C016**

GERBER



DIAMETER: 1"

PAIR: **121C021**
DIVERTER: **121C006**



DIAMETER: 1-5/16"

SINGLE: **121C020**



DIAMETER: 1-7/16"

HOT: **121C019**
COLD: **121C018**

HARCRAFT

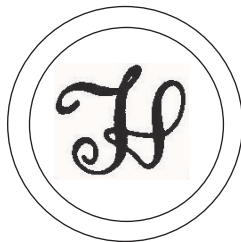

DIAMETER: 1-7/32"

HOT: **121C023**
COLD: **121C024**

KOHLER



DIAMETER: 13/16"

COLD: **121C066**
HOT: **121C067**

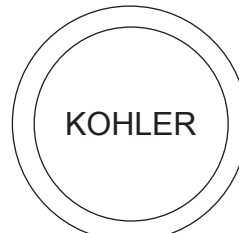

DIAMETER: 1-7/32"

EACH: **121C068**

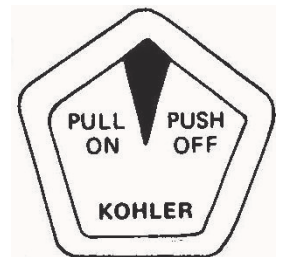















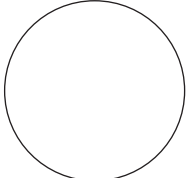



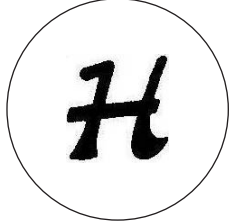

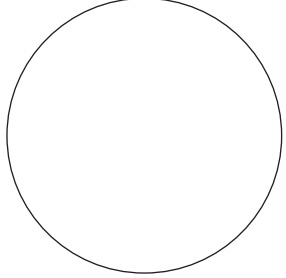

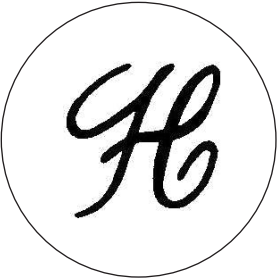





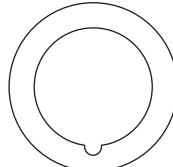

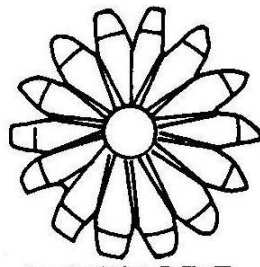
DIAMETER: 1-3/8"

EACH: **121C073**



INDIVIDUAL PARTS / FAUCET REPAIRS

INDEXES FOR FAUCET HANDLES (cont.)

1	MOEN DIAMETER: 1-9/16" EACH: 121C031  		PRICE PFISTER   DIAMETER: 1-1/16" PAIR: 121C075 ARROW: 121C077 BLANK: 121C078		  DIAMETER: 15/16" EACH: 121C092	  DIAMETER: 15/16" HOT: 121C081 COLD: 121C080 ARROW: 121C082	  DIAMETER: 1-5/32" HOT: 121C087 COLD: 121C086 P/P: 121C088
	POWERS   DIAMETER: 1-7/16" BLANK: 121C091	PRICE PFISTER   DIAMETER: 1-7/16" HOT: 121C089 COLD: 121C090 BLANK: 121C091		PRICE PFISTER AVANTE HANDLE INDEXES: (For handles shown at right)  OLD STYLE  NEW STYLE   BUTTON  RING BUTTONS: Old style plastic button: 9PF0979 New style chrome button: 9PF1061 New style arrow button: 9PF1062 RINGS: Ring, all blue: 9PF1063 Ring, all red: 9PF1064 Ring, blue & red: 9PF1065			
PRICE PFISTER BODYGUARD SHOWER HANDLE INDEX BUTTON   EACH: 9PF0997 MORE INFORMATION ON THIS VALVE ON PAGE 1-66	PRICE PFISTER   DIAMETER: 1-3/8" EACH: 121C085	PRICE PFISTER  DIAMETER: 1-1/16" HOT: 9PF0992 COLD: 9PF0991 ARROW: 9PF0993	SAYCO  DIAMETER: 1-5/16" HOT: 121C035 COLD: 121C034 DIV: 121C039	SAYCO   DIAMETER: 9/16" HOT: 121C037 COLD: 121C036			
CREST GOOD CARRIES HUNDREDS OF INDEX BUTTONS NOT SHOWN ON THESE PAGES. CALL, FAX, OR EMAIL US WITH AN OEM NUMBER, OR SEND US A SAMPLE.	PRICE PFISTER  DIAMETER: 1-1/16" HOT: 9PF0992 COLD: 9PF0991 ARROW: 9PF0993	SAVOY  FOR LOOP HANDLE: RED/BLUE: 121C049 FOR SOLID HANDLE: RED/BLUE: 121C069	STERLING  DIAMETER: 1-1/8" HOT: 121C157 COLD: 121C158				
	T&S BRASS  COLORED RINGS: DIAMETER: 3/4" TS173F (hot - red) TS172F (cold - blue)	SNAP IN INDEXES: TS161F (cold - blue) TS162F (hot - red) TS163F (cold - green) TS164F (air - green) TS165F (vac - yellow) TS166F (gas - blue) TS167F (D.W. - white)	WATERSAVER DIAMETER: 3/4" 121C042 (cold - green) 121C043 (hot - red) 121C044 (vac - yellow) 121C047 (air - orange) 121C041 (DW - white)				

